

AD 738842

AD

USAAMRD TECHNICAL REPORT 72-1

WIRE-BRAIDED HOSE CHAFING TESTS

Details of illustrations in
this document may be better
studied on microfiche

By

Donald R. Artis, Jr.

January 1972

**EUSTIS DIRECTORATE
U. S. ARMY AIR MOBILITY RESEARCH AND DEVELOPMENT LABORATORY
FORT EUSTIS, VIRGINIA**

AD 738842
RECEIVED
MATERIAL COMMAND

Approved for public release;
distribution unlimited.



Reproduced by
NATIONAL TECHNICAL
INFORMATION SERVICE
Springfield, Va. 22151

72

DISCLAIMERS

The findings in this report are not to be construed as an official Department of the Army position unless so designated by other authorized documents.

When Government drawings, specifications, or other data are used for any purpose other than in connection with a definitely related Government procurement operation, the United States Government thereby incurs no responsibility nor any obligation whatsoever; and the fact that the Government may have formulated, furnished, or in any way supplied the said drawings, specifications, or other data is not to be regarded by implication or otherwise as in any manner licensing the holder or any other person or corporation, or conveying any rights or permission, to manufacture, use, or sell any patented invention that may in any way be related thereto.

Trade names cited in this report do not constitute an official endorsement or approval of the use of such commercial hardware or software.

DISPOSITION INSTRUCTIONS

Destroy this report when no longer needed. Do not return it to the originator.

ACCESSION IS	
CFSTI	WRITE SECTION <input checked="" type="checkbox"/>
DOC	REF. SECTION <input type="checkbox"/>
UNCLASSIFIED	<input type="checkbox"/>
JUSTIFICATION	
DISTRIBUTION AVAILABILITY CODES	
DISC.	AVAIL. CODE/SPECIAL
A	

Unclassified

Security Classification

DOCUMENT CONTROL DATA - R & D

(Security classification of title, body of abstract and indexing annotation must be entered when the overall report is classified)

ORIGINATING ACTIVITY (Corporate author) Eustis Directorate U. S. Army Air Mobility R&D Laboratory Fort Eustis, Virginia		2a. REPORT SECURITY CLASSIFICATION Unclassified	
		2b. GROUP	
1. REPORT TITLE WIRE-BRAIDED HOSE CHAFING TESTS			
4. DESCRIPTIVE NOTES (Type of report and inclusive dates)			
3. AUTHOR(S) (First name, middle initial, last name) Donald R. Artis, Jr.			
6. REPORT DATE January 1972		7a. TOTAL NO. OF PAGES 75	7b. NO. OF REFS 2
8a. CONTRACT OR GRANT NO.		9a. ORIGINATOR'S REPORT NUMBER(S) USAAMRDL Technical Report 72-1	
b. PROJECT NO.		9b. OTHER REPORT NO(S) (Any other numbers that may be assigned this report)	
c. Task 1F162205A11906			
d. House Task S70-13			
10. DISTRIBUTION STATEMENT Approved for public release; distribution unlimited.			
11. SUPPLEMENTARY NOTES		12. SPONSORING MILITARY ACTIVITY Eustis Directorate U. S. Army Air Mobility R&D Laboratory Fort Eustis, Virginia	
13. ABSTRACT This report presents the results of a series of tests conducted to determine the chafing characteristics of wire-braided hoses in an Army helicopter vibration environment. These tests were prompted by the large number of chafed wire-braided hoses noted by the U. S. Army Board for Aviation Accident Research, Fort Rucker, Alabama. The primary causes for these hoses' coming into contact with one another are poor maintenance practices and inadequate consideration of the possibility of those practices by the aircraft designers. The tests were conducted by vibrating wire-braided hoses against one another until they failed or reached the predetermined termination test time. Failure was defined as a loss of hydraulic fluid through a worn or punctured lining at the point of contact. Once a mean time between failure was established for the unprotected (no chafe guard) hoses, various chafing protection schemes and materials were examined for their effectiveness. It was determined that spiral-cut nylon tubing represented the best chafing protection examined for wire-braided hoses. Therefore, as an interim solution to the wire-braided hose chafing problem, nylon coil wrapped around the hoses would provide a reasonably good chafe guard. A recommendation was made to initiate a program to develop a chafe-resistant hose for use on future Army aircraft to replace the wire-braided hose currently used.			

DD FORM 1473
1 NOV 65

REPLACES DD FORM 1473, 1 JAN 54, WHICH IS OBSOLETE FOR ARMY USE.

Unclassified

Security Classification

Unclassified

Security Classification

14.	KEY WORDS	LINK A		LINK B		LINK C	
		ROLE	WT	ROLE	WT	ROLE	WT
	Wire-Braided Hose Chafing Problems Hydraulic Systems Aircraft Safety						

Unclassified

Security Classification

12572-71

Task 1F162205A11906
House Task S70-13
USAAMRDL Technical Report 72-1
January 1972

WIRE-BRAIDED HOSE CHAFING TESTS

Final Report

By

Donald R. Artis, Jr.

EUSTIS DIRECTORATE
U. S. ARMY AIR MOBILITY
RESEARCH AND DEVELOPMENT LABORATORY
FORT EUSTIS, VIRGINIA

Approved for public release;
distribution unlimited.

SUMMARY

This report presents the results of a series of tests conducted to determine the chafing characteristics of wire-braided hoses in an Army helicopter vibration environment. These tests were prompted by the large number of chafed wire-braided hoses noted by the U. S. Army Board for Aviation Accident Research, Fort Rucker, Alabama. The primary causes for these hoses' coming into contact with one another are poor maintenance practices and inadequate consideration of the possibility of those practices by the aircraft designers.

The tests were conducted by vibrating wire-braided hoses against one another until they failed or reached the predetermined termination test time. Failure was defined as a loss of hydraulic fluid through a worn or punctured lining at the point of contact. Once a mean time between failure was established for the unprotected (no chafe guard) hoses, various chafing protection schemes and materials were examined for their effectiveness.

It was determined that spiral-cut nylon tubing represented the best chafing protection examined for wire-braided hoses. Therefore, as an interim solution to the wire-braided hose chafing problem, nylon coil wrapped around the hoses would provide a reasonably good chafe guard. A recommendation was made to initiate a program to develop a chafe-resistant hose for use on future Army aircraft to replace the wire-braided hose currently used.

Preceding page blank

FOREWORD

This report covers a series of tests conducted to determine a solution to the chafing problem of wire-braided hoses used on U. S. Army aircraft. These tests were conducted under DA Task 1F162205A11906, "Reliability/Environmental Technology," House Task S70-13. This effort is part of the reliability and maintainability effort at the Eustis Directorate, U. S. Army Air Mobility Research and Development Laboratory, Fort Eustis, Virginia.

Technical assistance and advice were provided by Mr. Benny J. Jones, engineering technician, who designed the test fixture and hydraulic pressure system; Mr. Edgar H. McIlwean, electronic technician, who operated the test equipment; Mr. Roger B. Hayman, Jr., equipment specialist, who assisted and advised the project engineer throughout the tests; and Major Vincent G. Ripoll, U. S. Army aviation maintenance officer, who contributed to the writing of this report from a maintenance standpoint.

Preceding page blank

TABLE OF CONTENTS

	<u>Page</u>
SUMMARY.	iii
FOREWORD.	v
LIST OF ILLUSTRATIONS	viii
LIST OF TABLES.	xi
LIST OF SYMBOLS	xii
INTRODUCTION.	1
PRELIMINARY INVESTIGATIONS	3
TESTING PROGRAM	5
CONCLUSIONS	14
RECOMMENDATIONS.	15
LITERATURE CITED.	17
APPENDIXES	
I. Effect of Contact Pressure on Chafing Time To Failure	18
II. Hose-Against-Hose Vibration Test	24
III. Modification of Standard Hoses To Improve Hose Chafing Characteristics	41
IV. Hose Clamp Substitute.	63
DISTRIBUTION	65

LIST OF ILLUSTRATIONS

<u>Figure</u>		<u>Page</u>
1	Contacting Hydraulic Hoses With Clamps in Place Aboard an AH-1G Helicopter.	2
2	Wire-Braided (Unprotected or Standard) Hoses Used During Testing	6
3	Vibration Fixture Assembly	7
4	Hydraulic Schematic.	8
5	Electrical Schematic.	9
6	Spring Scale	20
7	Contact Force Versus Time to Failure.	21
8	Test Specimens 20AC and 20BD	22
9	Test Specimens 21AC and 21BD	22
10	Test Specimens 22AC and 22BD	23
11	Test Specimens 1A and 1B in Test Orientation	24
12	Test Specimens 1A and 1B	25
13	Test Specimens 2AC and 2BD	29
14	Test Specimens 3AC and 3BD	29
15	Test Specimens 4AC and 4BD	30
16	Test Specimens 5AC and 5BD	30
17	Test Specimens 6AC and 6BD	31
18	Test Specimens 7AC and 7BD	31
19	Test Specimens 8AC and 8BD	32

<u>Figure</u>		<u>Page</u>
20	Test Specimens 9AC and 9BD	32
21	Test Specimens 10AC and 10BD	33
22	Test Specimens 11AC and 11BD	33
23	Test Specimens 12AC and 12BD	34
24	Test Specimens 13AC and 13BD	34
25	Test Specimens 14AC and 14BD	35
26	Test Specimens 15AC and 15BD	35
27	Test Specimens 16AC and 16BD	36
28	Test Specimens 17AC and 17BD	36
29	Test Specimens 18AC and 18BD	37
30	Test Specimens 19AC and 19BD	37
31	Vibration Fixture Assembly	38
32	Hydraulic Assembly	39
33	Relative Frequency Histogram	40
34	Test Specimens 23AC and 23BD	47
35	Test Specimens 24AC and 24BD in Test Fixture	48
36	Test Specimens 24AC and 24BD	49
37	Test Specimens 25AC and 25BD	50
38	Test Specimens 26AC and 26BD	50
39	Test Specimens 27AC and 27BD	51
40	Test Specimens 28AC and 28BD	51
41	Test Specimens 29AC and 29BD	52

<u>Figure</u>		<u>Page</u>
42	Test Specimens 30AC and 30BD	53
43	Test Specimens 31AC and 31BD	54
44	Test Specimens 32AC and 32BD	54
45	Test Specimens 33AC and 33BD	55
46	Test Specimens 34AC and 34BD	55
47	Test Specimens 35AC and 35BD	56
48	Test Specimens 36AC and 36BD in Test Fixture . .	56
49	Test Specimens 36AC and 36BD Separated	57
50	Test Specimens 37AC and 37BD	57
51	Test Specimen 38AC 2024-T4 Sheet Aluminum . . .	58
52	Test Specimen 39AC 2024-T4 Sheet Aluminum . . .	58
53	Test Specimen 40AC Clamp No. 7.	59
54	Test Specimen 41AC	60
55	Test Specimen 41AC Clamp No. 6.	60
56	Test Specimen 42AC in Test Fixture With No. 8 MS 21919 Clamp Covered With Hydraulic Fluid and Sand . . .	61
57	Test Specimen 42AC	62
58	Test Specimen 42AC Clamp No. 8	62
59	Polypropylene Spacer for Army Aircraft Hydraulic Tubing Separators.	64

LIST OF TABLES

<u>Table</u>		<u>Page</u>
I	Test Specimen Data for Standard Hose-to-Hose Tests	11
II	Correlation of Coil and Clamp Sizes With Hose Sizes	16
III	Determination of the Effect of Contact Force	19
IV	MTBF of Standard Wire-Braided Hoses	27
V	Wire-Braided-Hose Frequency of Failure	28
VI	Test Specimen Data for Modified Standard Hose Tests	43

LIST OF SYMBOLS

D	displacement, peak to peak, in.
E	allowable error
f	frequency, cycles per second
g	acceleration due to gravity, 32.17 ft/sec ²
n	sample size
Pr	probability
s	sample deviation
s ²	sample variance
\bar{X}	sample mean
α	customer's risk or level of significance
1- α	confidence
μ	population mean

INTRODUCTION

During the design and mock-up evaluation phase of an aircraft development program, the aircraft's hydraulic system hose locations and routing and the appropriate maintenance practices for that aircraft are established, usually with great skill and forethought. Unfortunately, some of these hoses manage to come in contact with each other or with the aircraft structure and cause chafing that could result in either forced or precautionary landings, incidents, or even accidents.

The monthly maintenance summaries published by the U. S. Army Board for Aviation Accident Research (USABAAR) have indicated a continual recurrence of hydraulic system failures due to chafed hydraulic hoses. These reports give no indication of time to failure, but they do highlight maintenance error as the primary contributor to the failures. A grouping of the aircraft incidents resulting from aircraft hydraulic hose chafing, cracked or loose fittings, and loose hydraulic lines shows that from July 1968 to August 1969 (excluding 16 November 1968 through 15 December 1968), at least 114 incidents, precautionary or forced landings, or accidents involving the UH-1 and 15 involving the AH-1G were reported. Although this study reflects the data available for the above dates, the weekly summaries published by USABAAR continue to indicate that a significant portion of Army aircraft mishaps are a result of hydraulic system problems. Most of these hydraulic-system-caused mishaps were precautionary landings, but some were forced landings or major accidents. Generally, chafed or broken hydraulic lines account for about one-third of all Army aircraft mishaps that can be attributed to the hydraulic system.

Missing or improperly located clamps, incorrect clamp sizes, and twisted lines were a few of the maintenance errors noted by USABAAR. Poor line routing, insufficient number of restraining clamps, and insufficient hose chafe guards were a few of the design errors noted.

The present method for maintaining the separation of hydraulic lines to prevent chafing is a metal clamp with a rubber cushion located between the clamp and the hose (FSN 5340-990-9301). Separation clamps keep the hoses apart at the point where the clamp is attached; however, the hose fittings could be torqued in such a way that the hoses could contact one another, resulting in chafing. This can be seen in the AH-1G hydraulic hose installation shown in Figure 1. The two hoses shown in Figure 1 are in contact even though a clamp is in place on the hoses.

The contact force between the hoses was 1 pound, as measured by the method described in Appendix I. Further inspection of the AH-1G, which was selected at random, revealed three other hydraulic hose installations where the hoses were in contact with one another under static conditions. This aircraft was in a peacetime environment, with good maintenance facilities available and adequate time for thorough inspection. The fact that chafing occurs under these conditions is proof that clamps alone are not an adequate solution to wire-braided hose chafing problems. Moreover, if chafing occurs under these conditions, it will certainly occur in a combat environment where maintenance conditions are less than ideal.

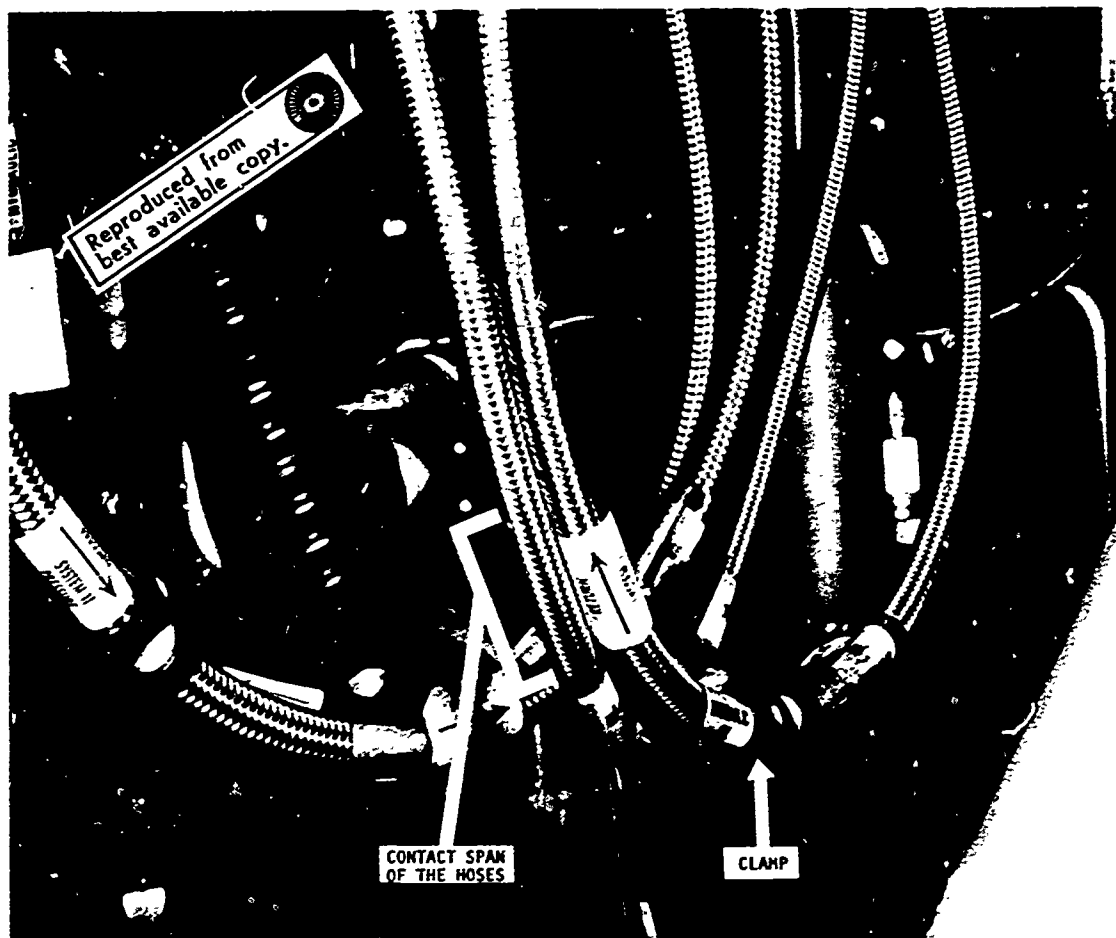

Figure 1. Contacting Hydraulic Hoses With Clamps in Place Aboard an AH-1G Helicopter.

PRELIMINARY INVESTIGATIONS

FIELD INSPECTION

Prior to conducting the hose tests described in this report, a field inspection of Army aviation maintenance practices and procedures was conducted. A random sample of operating AH-1G and UH-1C helicopters was examined for wire-braided hose problems. Of the two AH-1G's inspected (in addition to one previously discussed), one was flyable and the other was undergoing the final stages of scheduled maintenance. On the flyable AH-1G, two hoses leading from the lockout valve assembly (P/N 204-076-012-3) to the collective servo cylinder (P/N 209-076-021-1) were chafing approximately midway between the hose fittings. The AH-1G undergoing the scheduled maintenance also had lines chafing in both systems, but no entry had been made on the DA Form 2404 by the technical inspectors or the aircraft crew. DA Form 2404, "Equipment Inspection and Maintenance Worksheet," is used to record required scheduled maintenance for Army equipment and discrepancies noted during that maintenance. The visual inspection of the UH-1C, which was also in scheduled maintenance, revealed a probable chafing situation. To be certain that chafing would occur, hydraulic pressure would have to be applied to the system; however, pressure was not applied so a final determination of the probability of chafing was not made at that time.

HOSE CLAMP STUDY

During the investigation of the two AH-1G's and the UH-1C, the use of hose clamps was studied. It became readily apparent that the proper use of clamps was left to the discretion of the maintenance crews, and that the inspectors depended largely on experience for acceptance of hose installations. The technical manual (TM) series 55-1520-XXX-20, -35, -20P, and -35P do not agree concerning the number of clamps to be used nor the distance by which each clamp should be separated from other clamps.

In the organization maintenance manuals (TM 55-1520-XXX-20), the applicable figures do not indicate the use of clamps at all. Apparently to keep the figures clear and uncluttered, the clamps are omitted. The direct support, general support, and depot parts manuals show the position of only one clamp separating two hoses, one 20 and the other 24 inches long. The TM 55-1520-XXX-35P's further note that to use the correct clamp size to separate or secure a given hose assembly, the

crew must refer to Technical Bulletin (TB) 750-125,¹ no tables on clamp sizes are available in the pertinent -20 and -35 manuals. The -20 technical manual does not contain any information on removal or installation of hoses and hose assemblies. TB 750-125,¹ Section VIII, paragraph 18, is the authority for reinstallation of hose assemblies. This same TB stresses the use of clamps as supports for hoses and hose assemblies and contains some instructions for separating hoses that are routed along the same path. In addition, TM 55-1500-204-25/1 gives the "shop-practice:" replacement criteria for wire-braided hoses.

A crew member needs three separate manuals to check, install, replace, or repair a hose assembly and its clamps (TM 55-1520-XXX-30, TB 750-125, and TM 55-1500-204-25/1). Whenever the use of clamps is discussed, statements like "sufficient number," "properly located," or "in accordance with appropriate technical manuals" are the only instructions given, thereby causing confusion concerning the proper number and correct method of attaching hose clamps.

When a hose is to be manufactured or assembled at the organizational maintenance level, it is usually patterned after the hose that failed, so any error in length or size that existed in the original, or failed, hose is repeated. This practice is commonplace apparently because the instructions given in the technical manuals are complex or are incomplete.

TESTING PROGRAM

INTRODUCTION

A testing program was conducted to determine the time to failure due to chafing of wire-braided hoses used on Army aircraft and to investigate methods of increasing hose life. Various attempts to increase the time to failure were made, and the effectiveness of each attempt was evaluated.

The test specimens were high-temperature, medium-pressure tetrafluoroethylene hoses, MIL H-27267A, with an outside diameter of 0.465 inch and an operating pressure of 1500 psi (see Figure 2). The test hoses were 15-5/8 inches long.

OBJECTIVES

The test objectives were as follows:

1. Investigate and determine the mean time between failures (MTBF) for unprotected hoses when vibrating at the hose resonant frequency in the orientation shown in Figure 3. Figures 4 and 5 show the hydraulic and electrical schematics of the test system respectively.
2. Repeat the test described above under the same conditions, evaluating the effect of proposed chafe guards on the MTBF of the hoses.
3. Investigate the effect on MTBF of an unprotected hose rubbing against sheet metal, which is representative of aircraft structure or components.
4. Conduct related investigations that are pertinent to the determination of hose chafing characteristics.

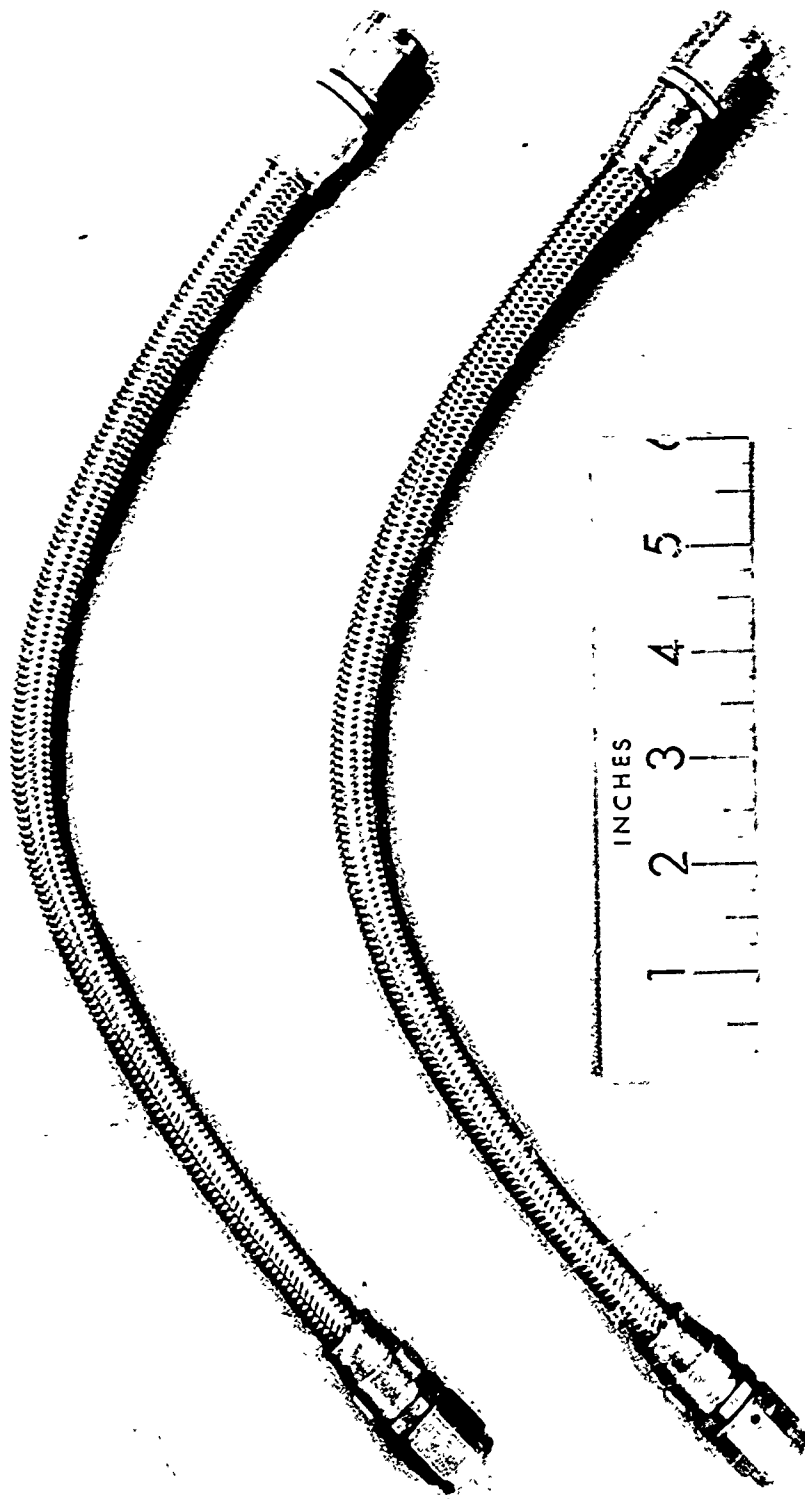

Figure 2. Wire-Braided (Unprotected or Standard) Hoses
Used During Testing.

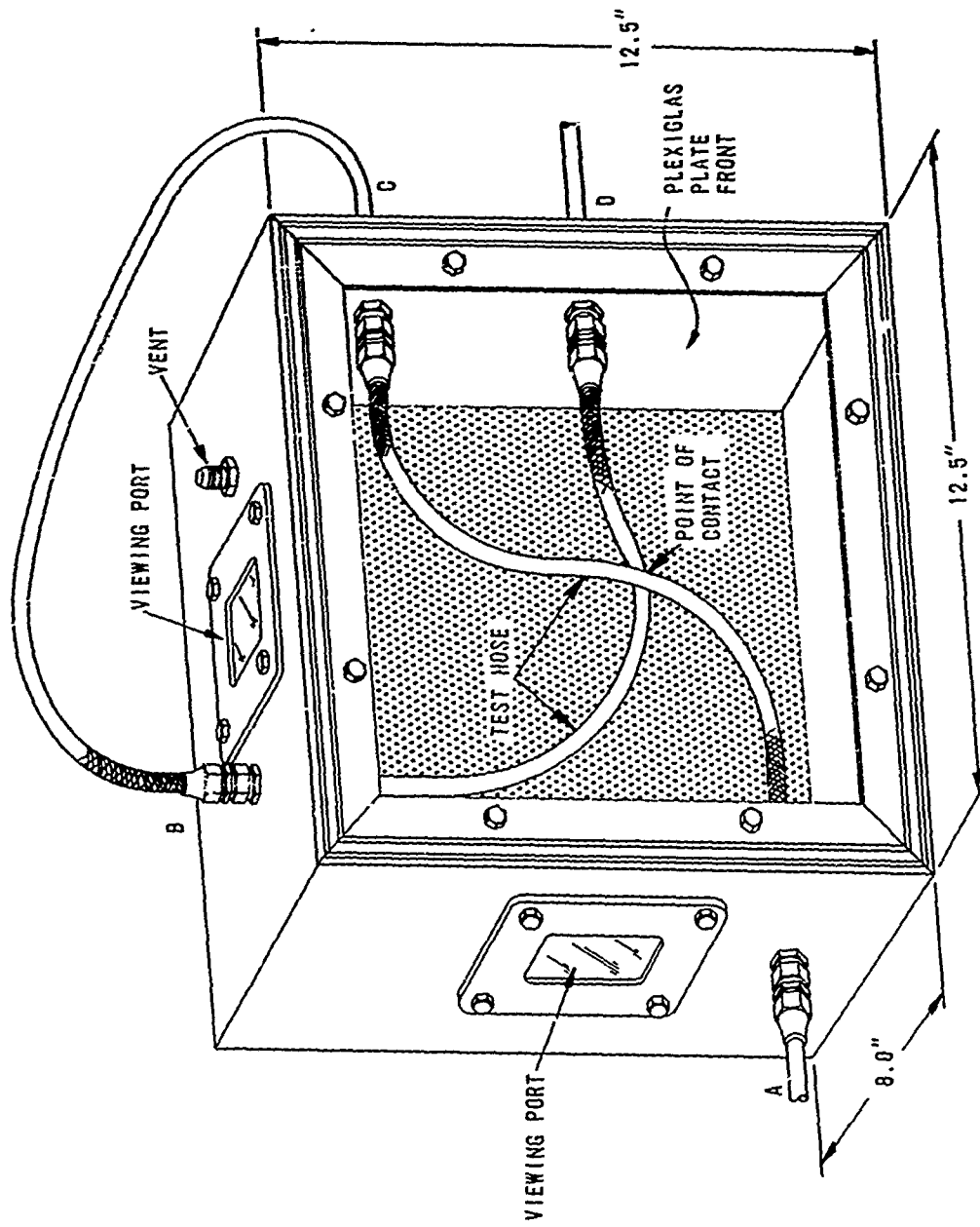
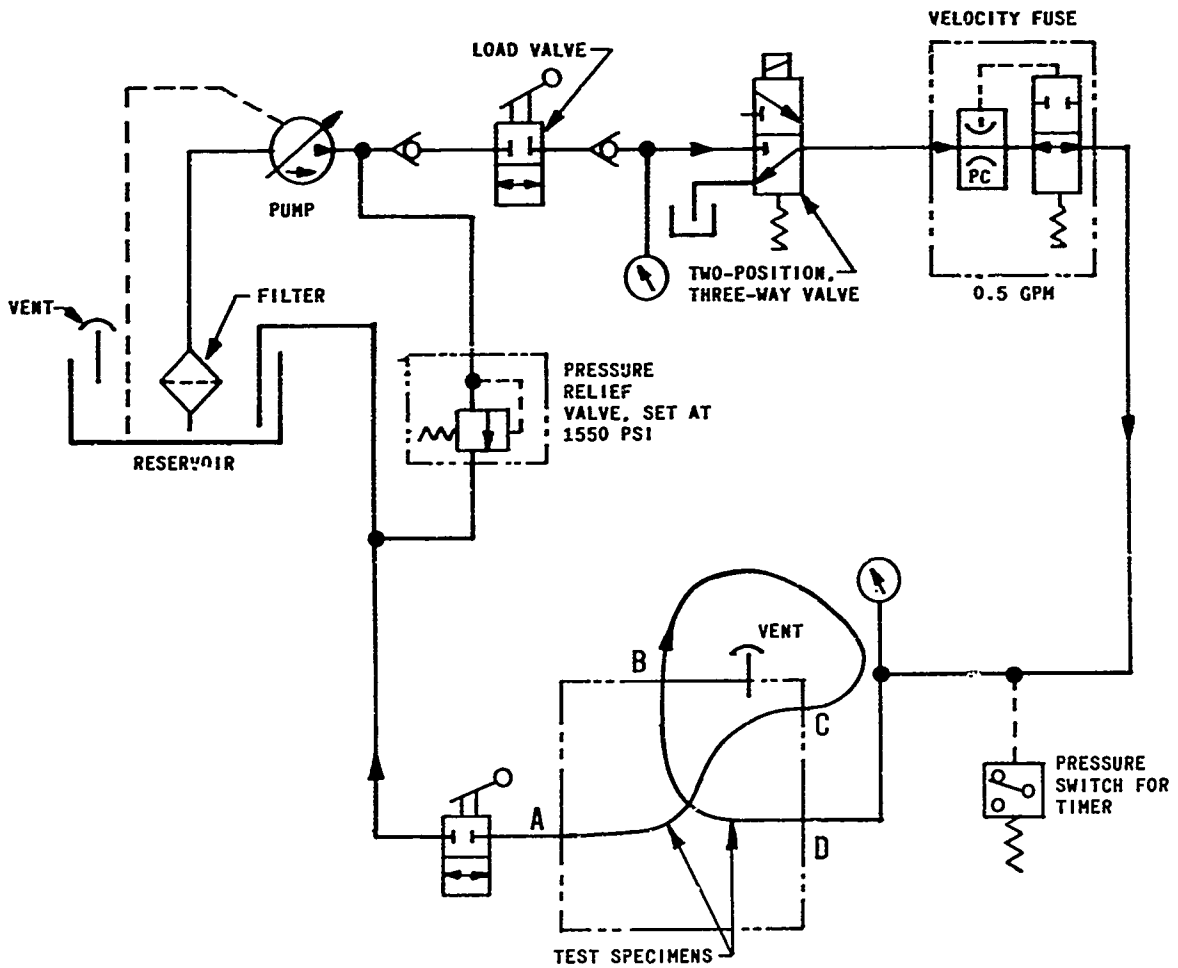





Figure 3. Vibration Fixture Assembly.



LEGEND

-  - PRESSURE GAGE
-  - CHECK VALVE
-  - DIRECTION OF FLOW

1500 PSI MAINTAINED GAGE PRESSURE

MIL-H-5606 FLUID
2 GPM MAX FLOW

Figure 4. Hydraulic Schematic.

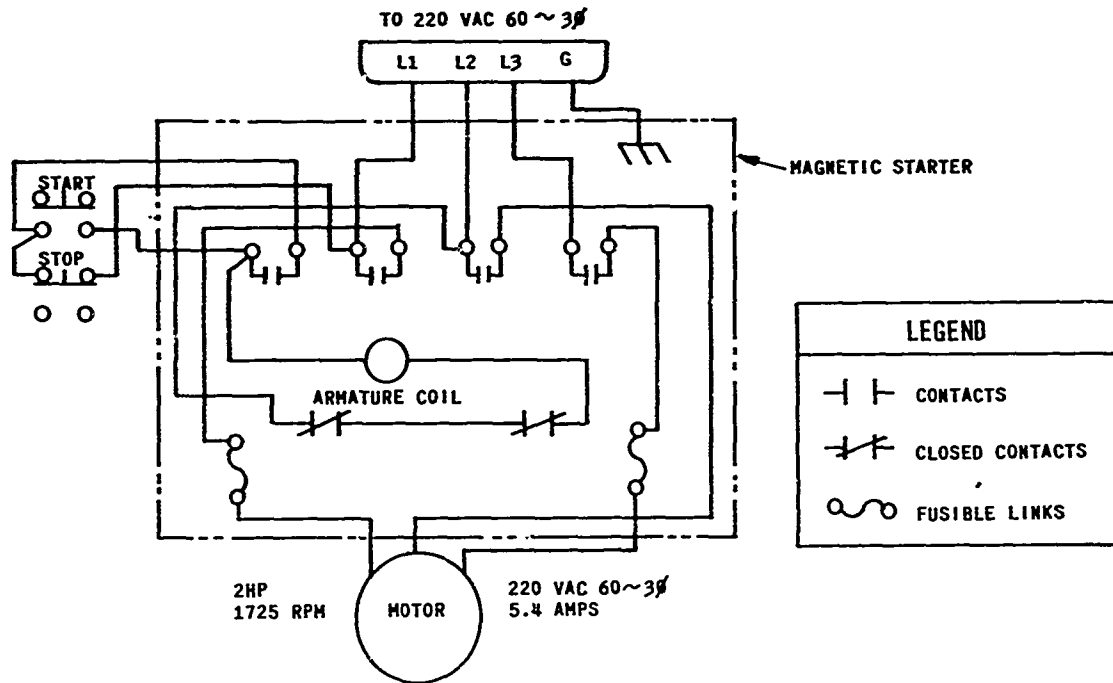

HYDRAULIC PUMP DRIVE MOTOR CIRCUIT

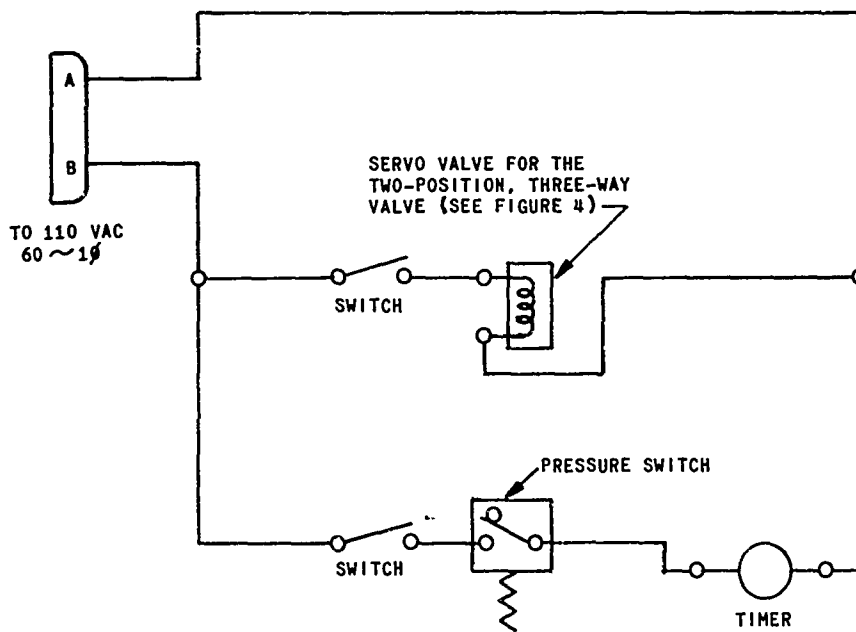

HYDRAULIC CONTROL CONSOLE

Figure 5. Electrical Schematic.

STANDARD HOSE TESTS

Six pairs of standard hoses were examined as described in Appendix II before a resonant frequency for testing to failure was chosen. That frequency was determined to be 100 cycles per second and was held constant for all the tests with a shaker table input displacement of 0.040-inch double amplitude to achieve an acceleration of 20g. The 20g acceleration test condition was chosen since it was representative of severe operating loads measured on UH-1D aircraft.²

Twenty-eight unprotected wire-braided hoses were tested, hose against hose, to determine the mean time between failures under test conditions. These hoses were tested at ambient temperature conditions ($\approx 70^{\circ}\text{F}$) and vibrated at 100 cycles per second. A 1500-psi static internal pressure was maintained using hydraulic fluid, and the hoses were held together with a contact force (as described in Appendix I) of approximately 4 pounds and a 0.040-inch double amplitude shaker displacement until the hoses wore at the point of contact and leaked hydraulic fluid (failure). Their times to failure were then recorded. Table I lists the test specimen data for the unprotected hose tests and the tests conducted to determine the resonant frequency of the hoses. The MTBF of the hoses under these conditions was determined to be approximately 107 minutes. Using 107 minutes (1.78 hours) as the reference MTBF, a maximum or test termination time of 27.78 hours (100,000 seconds) was assumed to be adequate to show a significant improvement for any attempted fix (see Appendix III). A fix was defined as a material that protects the wire-braided hose from chafing while having as little logistical impact as possible at minimum cost.

TESTING OF COVERINGS

Samples of nylon coil, tetrafluoroethylene coil, polyvinylchloride, and tetrafluoroethylene tape were tested as coverings (fixes) to determine their ability to improve the chafing characteristics of the hoses under the test conditions previously noted. These particular materials were selected because of their availability, their ease of application, or their present use by industry as hose chafe guards. The same number of samples for each covering were not tested; tetrafluoroethylene tape was dropped after two tests, and polyvinylchloride was dropped after one test.

The various coverings were tested at the same resonant frequency and amplitude used during the unprotected hose-to-hose tests, and either the time to failure or the test termination time (27.78 hours) of each sample

TABLE I. TEST SPECIMEN DATA FOR STANDARD HOSE-TO-HOSE TESTS			
Specimen Number	Time to Failure (min)	Shaker Table Frequency (cps)	Shaker Table Amplitude (in. peak to peak)
2AC (F)* 2BD	96.3	83.0	0.04
3AC (F) 3BD	38.9	87.5	0.04
4AC 4BD (F)	47.8	81.0	0.05
5AC 5BD	Dropped	Dropped	
6AC (F) 6BD	104.0	99.3	0.04
7AC (F) 7BD	156.0	101.0	0.04
8AC 8BD (F)	194.0	97.0	0.04
9AC 9BD (F)	161.0	100.0	0.04
10AC 10BD (F)	42.0	100.0	0.04
11AC 11BD (F)	26.5	100.0	0.04
12AC (F) 12BD	100.0	100.0	0.04
13AC 13BD (F)	107.0	100.0	0.04
14AC 14BD (F)	109.0	100.0	0.04
15AC (F) 15BD	18.4	100.0	0.04
16AC 16BD (F)	15.4	100.0	0.04
17AC 17BD (F)	249.5	100.0	0.04
18AC 18BD (F)	115.5	100.0	0.04
19AC 19BD (F)	98.6	100.0	0.04

*(F)-Hose losing hydraulic fluid due to chafing at crossing point of hoses AC and BD (see Figure 3)

was recorded, as appropriate. The MTBF obtained during tests conducted for each covering was compared with the MTBF of the unprotected hoses. The test procedure and results are presented in Appendix III.

Nylon coil appears to offer the best solution to the problem of prevention of hose chafing; it was the least expensive material tested that lasted until the test termination time, was the easiest material to install, and possibly could be reused if the hoses are replaced.

A weight analysis was made of the nylon coil that would be required to cover the wire-braided hoses on the UH-1C helicopter. This aircraft was selected because it has a dual hydraulic system and hence has more wire-braided hoses than the other models of the UH-1. Therefore, it would require more added weight in terms of hose covers than other utility-type helicopters. Only 0.80 pound of nylon coil was required to cover all the wire-braided hoses found on the UH-1C. It is estimated that it would require one man-day to install the nylon coil required to cover all the wire-braided hoses on a UH-1C.

TESTING WITH SHEET ALUMINUM

After completion of the above tests, noncovered (unprotected) hoses were tested to failure or test termination time against two thicknesses of 2024-T4 sheet aluminum, one sheet 0.032 inch thick and the other 0.062 inch thick. The steel braid on the hoses wore the aluminum down to the point that there was no contact between the hose and the sheet metal. The hose essentially was not chafed by the aluminum. Therefore, this test condition was not examined further.

TESTING WITH HOSE CLAMPS

As a more realistic test, an MS 21919 hose clamp was then used as the wearing surface; the rubber insert of the clamp was removed and the hose was permitted to rub against the unprotected clamp. The method of attachment was such that, under vibratory conditions, the hose would rub against one edge of the inside of the clamp. This test was intended to represent a "worst case" to determine wear characteristics of the aluminum clamp and steel braid.

The hoses wore through the clamps in both samples tested, while sustaining no detectable wear themselves. Therefore, it was concluded that, for these test conditions (Appendix III, paragraph 10), no chafing

of an unprotected hose could be produced by vibrating the hose within a hose clamp minus the clamp's rubber insert. However, this could still be a problem should the hose wear through a clamp and vibrate against some other aircraft component or another hose.

The effect of contact force on the hose-to-hose time to failure also verified the assumption that the MTBF is inversely proportional to the hose contact force. However, the time to failure has a limiting condition for both extremes of contact force; e. g. , the time to failure due to chafing for zero contact force is unlimited, and the time to failure due to chafing for a contact force that prohibits relative motion between the hoses is also unlimited. Contact forces greater than 5.25 pounds were not examined to determine chafing characteristics of the hoses. Safety wire was used to bind the hoses together to verify the contention that securing the hoses together would prevent abrasion at the point of contact, since relative motion between the hoses was prevented. Appendix III describes the safety wire test.

EVALUATION OF REPLACEMENT HOSE CLAMP

A replacement for hose clamp MS 21919, now in the inventory, was evaluated but not tested. The replacement was a polypropylene clamp shaped as described in Appendix IV.

ENVIRONMENTAL TEST

One additional test was conducted to determine if a failure could be induced by vibrating a hose within a loose-fitting hose clamp when the clamp and hose are covered with hydraulic fluid and sand. No wear of either the hose or the clamp was detected; therefore, this potential mode of failure was not considered to be significant.

CONCLUSIONS

It is concluded that:

1. The greater the contact force between wire-braided hoses, the shorter the time to failure or the mean time between failures. A practical limit to this condition is a force that precludes relative motion between the hose surfaces.
2. Placing any covering over the wire-braided hoses increases their time to failure. The most effective coverings tested were nylon 6/6 and nylon 6 coil. They are easy to use, are resilient, retain their molded shape better than tetrafluoroethylene coil (the other widely accepted chafe guard), and are comparatively inexpensive. They have an excellent ability to withstand wear and will not inhibit the movement of hoses that must move due to hydraulic-actuator or some similar operation. The nylon coil can be simply wrapped around the hose with no additional attachment to hold the coil in place. The coils need to be inspected periodically to insure that they are still in place and are not contacting components of the aircraft that they were not intended to touch; e. g. , other hoses, structural elements of the airframe, or components of the hydraulic system. The coils, in fact, might serve as good chafing indicators since the nylon coil discolors at the point of contact under wear conditions.
3. Placing a nylon coil over the wire-braided hoses not only protects the hoses against chafing but also protects other components of the aircraft that might come into contact with a hose. Should the steel wire braid of the hoses come into contact with aircraft components, the nylon coil would provide a much better chafe-resistant surface than bare wire braid.

RECOMMENDATIONS

The following recommendations are made to reduce or eliminate the problem of chafing of wire-braided hoses in future U. S. Army aircraft:

1. Amend those standards and specifications (such as MIL-H-27627) that describe design and test requirements for wire-braided hoses used on Army aircraft to account for chafing characteristics for those hoses that are qualified under that specification for use by future Army aircraft system developers.
2. Initiate an effort to develop a chafe-resistant replacement for the wire-braided hoses currently used on Army aircraft.
3. Conduct a study to devise a method of determining the exact number and location of hose clamps for each aircraft installation, and establish design and test requirements for assembling and installing hoses on Army aircraft that would preclude and/or minimize chafing problems.

The following recommendations are made to reduce damage caused by chafing of wire-braided hoses on current-inventory Army aircraft:

1. Perform the following investigations to assure that general-purpose translucent nylon 6 (polycaprolactum) or 6/6 (polyhexamethylene adipamide) coil is a compatible and safe fix for the wire-braided hose chafing problem when installed on Army aircraft:
 - a. Determine the necessity for binding the nylon coil at each end when installed on a hose to assure that the coil remains in place.
 - b. Study the effects of high ($>100^{\circ}\text{F}$) and low ($<32^{\circ}\text{F}$) temperature on the nylon coil's effectiveness as a chafe guard.
 - c. Perform a systems evaluation of the nylon coil's impact on effectiveness and service life by installing the coil on Army test aircraft.

- d. Test the compatibility of the nylon coil with Army aircraft fluids and with those fungi to which the nylon would most likely be exposed.
2. If tests show that nylon 6 and 6/6 coils are compatible when installed on Army aircraft, retrofit all Army aircraft with nylon-coil-covered wire-braided hoses.
3. Nylon 6/6 or nylon 6 coil can not be used in any location where the maximum service temperature exceeds 225°F. If a chafe guard is still required for high-temperature applications (greater than 225°F but less than 500°F), use tetrafluoroethylene coil as a substitute. Table II is a guide for determining the appropriate coil and clamp sizes to use with a particular wire-braided hose size.¹

TABLE II. CORRELATION OF COIL AND CLAMP SIZES WITH HOSE SIZES				
Hose Size*	Nylon Coil Size (OD, in.)**	Nylon Thickness (in.)	MS 21919 Clamp Size	
			Tetrafluoroethylene Insert	Rubber Insert
3	0.250	0.025	4	6
4	0.250	0.025	5	7
5	0.500	0.035	6	8
6	0.500	0.035	7	9
8	0.500	0.035	9	11
10	0.750	0.045	11	13
12	0.750	0.045	13	15
16	0.750	0.045	17	19
20	1.000	0.055	21	23
24	1.000	0.055	26	28

*Sizes as specified in MIL-H-27267A, 13 July 1965.
 **Outside diameter of the unstressed nylon coil at standard atmospheric conditions.

LITERATURE CITED

1. Department of the Army Technical Bulletin 750-125, Section VIII, 15 September 1966.
2. Leifer, Joseph C., and Peacock, Harold G., DESIGN CRITERIA FOR AN INSPECTION AND DIAGNOSTIC SYSTEM FOR THE UH-1D HELICOPTER, USAAVLABS Technical Report 70-46, U.S. Army Aviation Materiel Laboratories,* Fort Eustis, Virginia, November 1970, AD 879623.

*Redesignated Eustis Directorate, U. S. Army Air Mobility Research and Development Laboratory.

APPENDIX I
EFFECT OF CONTACT PRESSURE ON
CHAFING TIME TO FAILURE

The effect of the contact pressure on the time to failure was investigated to determine if there is a definite relationship between that force and the time to failure. The hoses examined during these tests were installed in the test fixture using the following techniques:

1. Insert the hoses so that they contact without twist and touch with the force achieved by the natural displacement of the two hoses lying against each other when the ends of the hoses are all in the same vertical plane (see Figure 3).
2. Once installed, turn the hoses at the fittings through an angle of approximately 7 degrees such that the hoses are forced together, as shown in Figure 3.

The above method is used to obtain a known contact force, but the angle noted in step 2 was varied in order to obtain the desired contact force. The contact force was measured by separating the hoses with a wire bar attached to a spring scale and the hooked end of the scale itself (see Figure 6). The spring scale was then read, and measurements were recorded.

Table III presents the data collected to determine the effect of hose contact force on time to failure under vibratory conditions. Figure 7 is a plot of the contact force versus time to failure of the hoses. Figures 8 through 10 show the additional failed wire-braided hoses tested to evaluate the effect of the contact force between the hoses.

Figure 7 shows that time to failure tends to decrease as the contact force between the hoses increases. It is conceivable that a contact force could be found that would be large enough to prevent relative motion between the hoses and thereby eliminate chafing. However, no attempt was made to determine that force since this method of preventing chafing is not considered to be an acceptable alternative to clamping.

TABLE III. DETERMINATION OF THE EFFECT
OF CONTACT FORCE*

Test Specimen	Contact Force (lb)	Time to Failure (min)
12AC (F)** 12BD	4.00	100.0
13AC 13BD (F)	4.50	107.1
14AC 14BD (F)	4.63	108.1
15AC (F) 15BD	5.25	18.4
16AC 16BD (F)	4.25	15.4
17AC 17BD (F)	2.50	249.5
18AC 18BD (F)	5.25	115.5
19AC 19BD (F)	2.87	98.6
20AC 20BD (F)	3.50	304.0
21AC 21BD (F)	3.50	302.5
22AC (F) 22BD	2.00	771.3

*Tested at shaker input conditions of 100 cps and 0.04-inch double amplitude.
 **(F)-Hose losing hydraulic fluid due to chafing at crossing point of hoses AC and BD (see Figure 3).

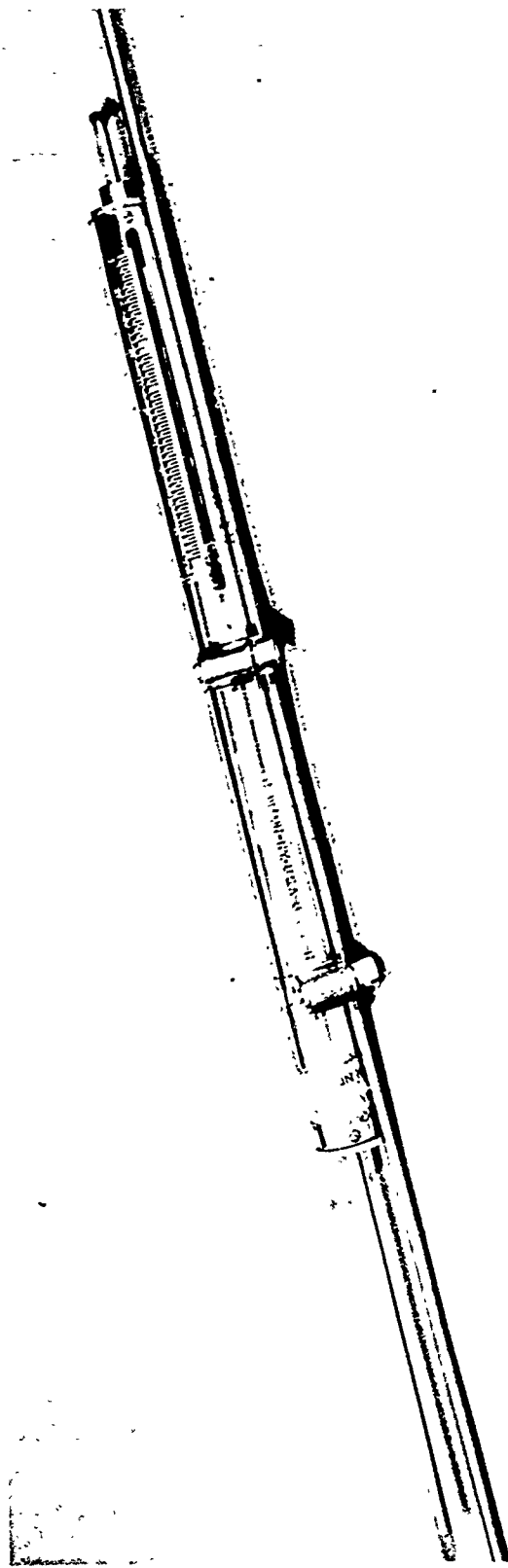

Figure 6. Spring Scale.

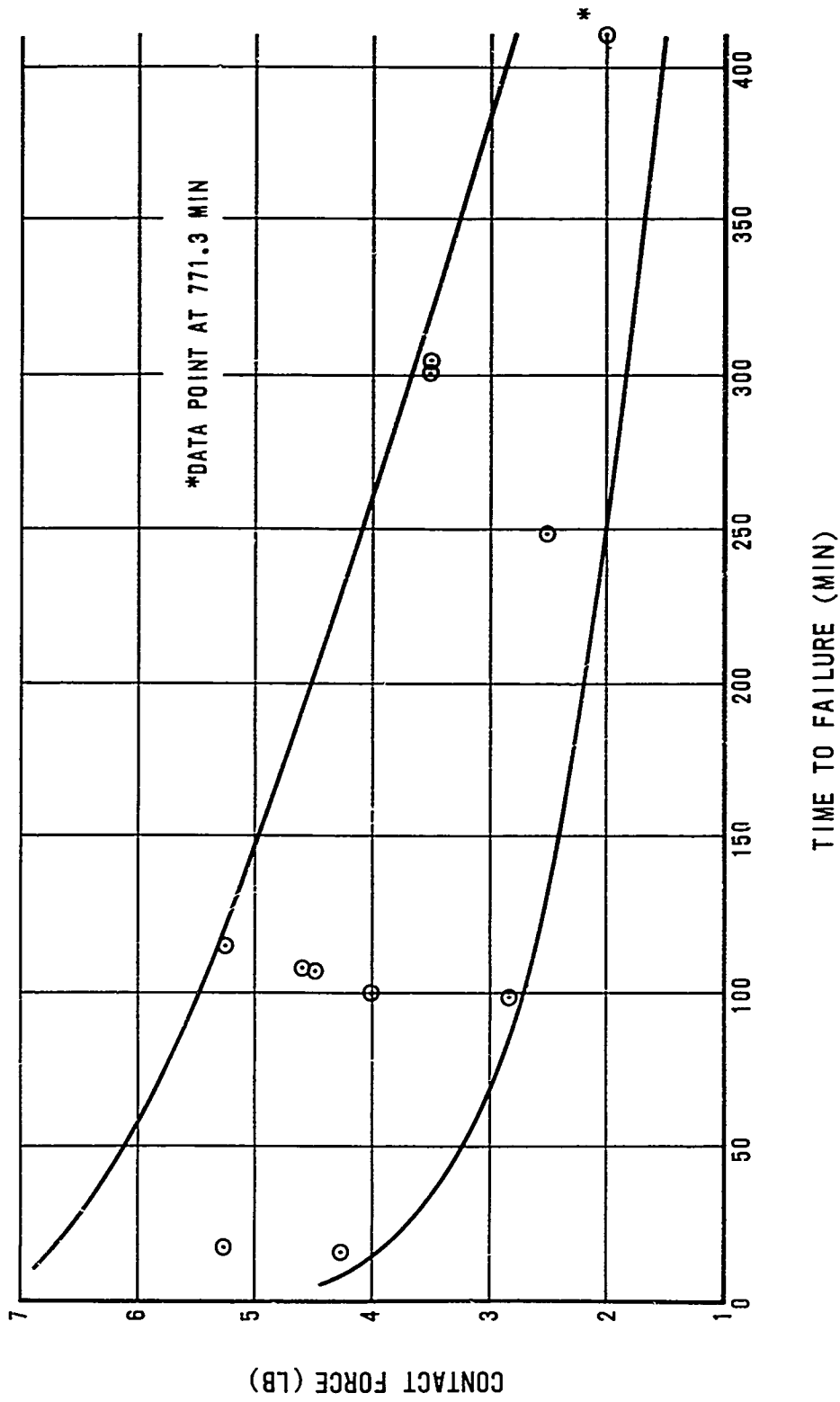

Figure 7. Contact Force Versus Time to Failure.

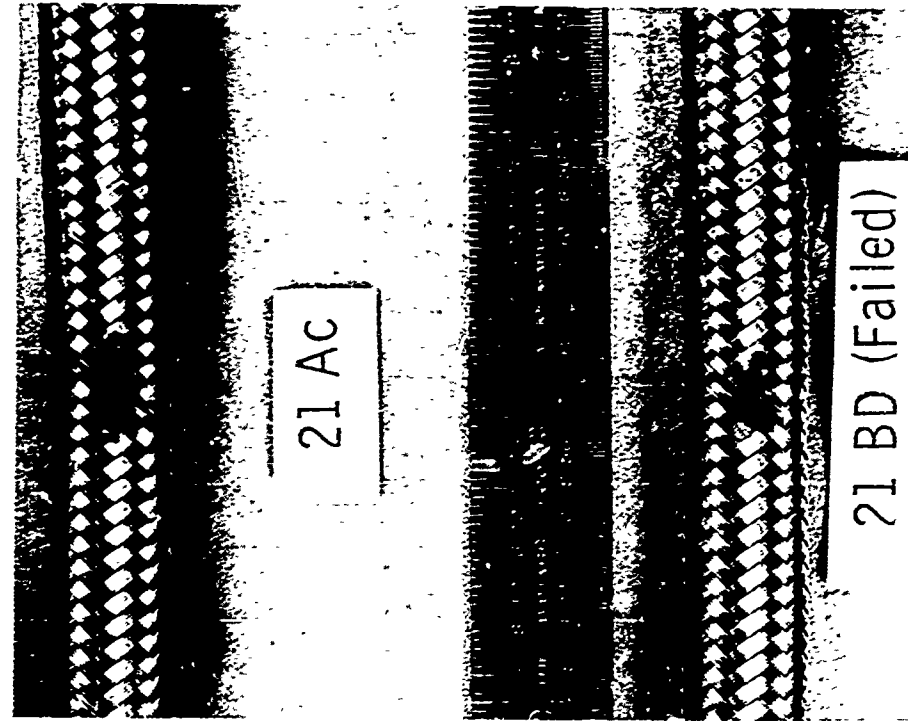

Figure 9. Test Specimens 21AC and 21BD.

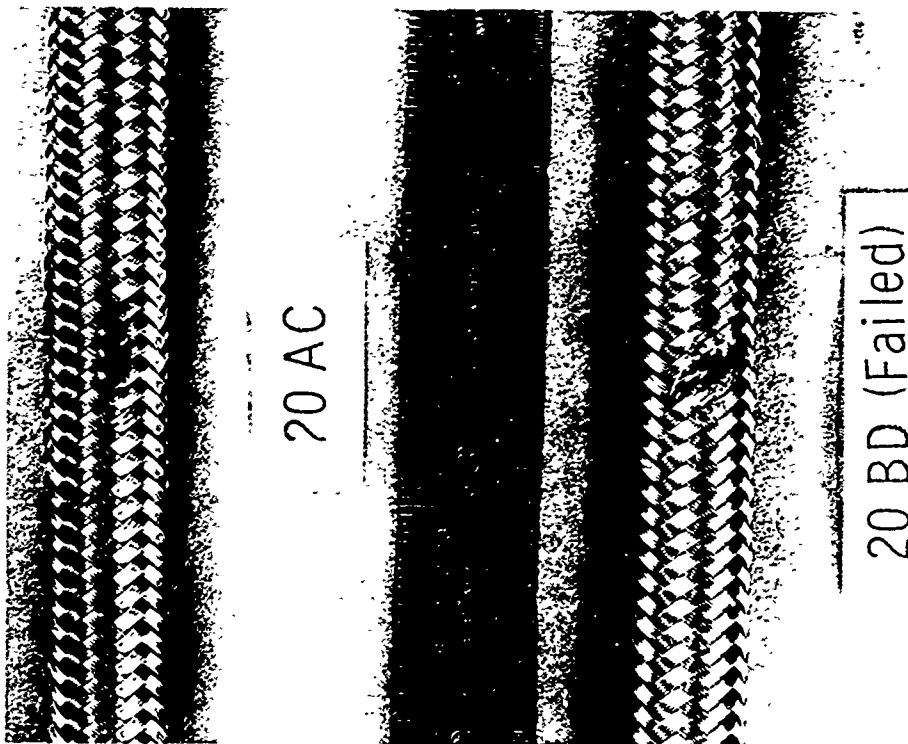

Figure 8. Test Specimens 20AC and 20BD.

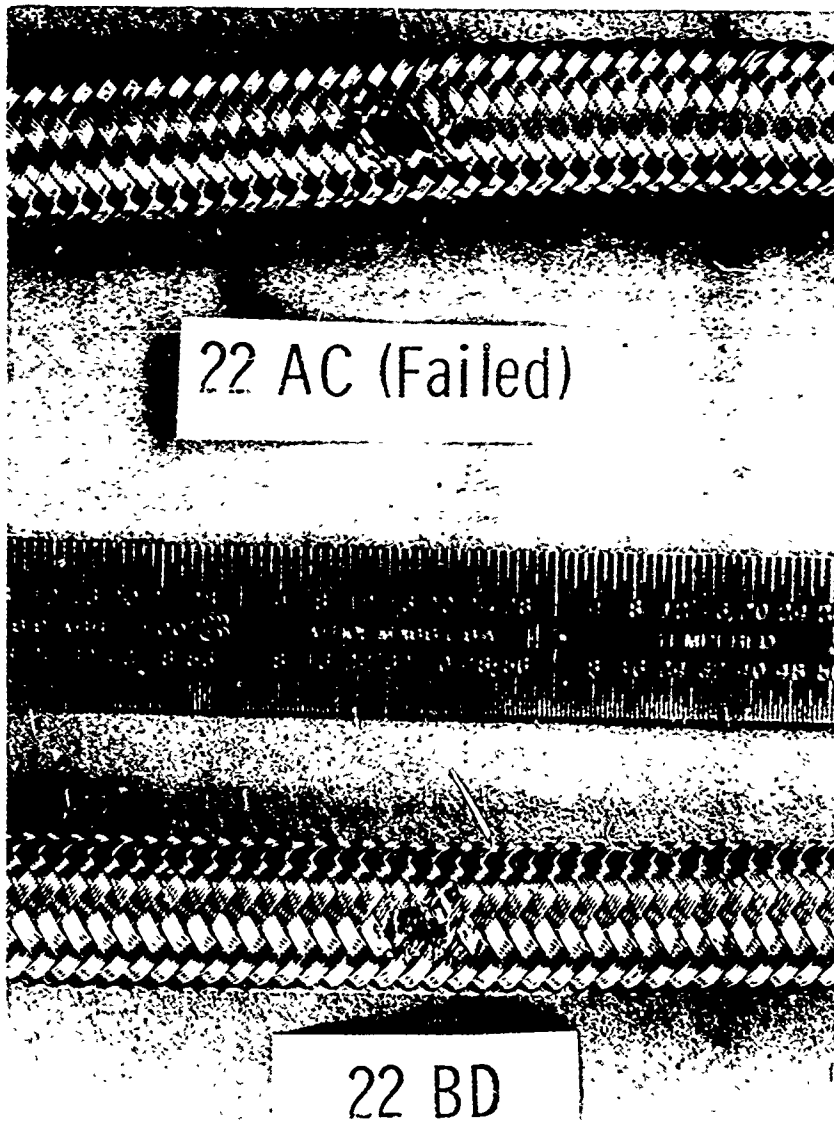

Figure 10. Test Specimens 22AC and 22BD.

APPENDIX II
HOSE-AGAINST-HOSE VIBRATION TEST

TEST SPECIMENS 1A AND 1B

Test specimens 1A and 1B were tested in a horizontal position with respect to the shaker table (see Figure 11) at their resonant frequency of 119 cycles per second and at 0.020-inch double amplitude. The test specimens were subjected to 1500 psig internal pressure using hydraulic fluid. The specimens were vibrated in that mode at 119 cycles per second for a total test time of 16 hours. Since about 40 tests were to be performed, the length of time required to obtain the wear shown in Figure 12 was judged to be excessively long. In an attempt to shorten the test time required for each specimen, the attitude of the hoses was changed to a vertical orientation with respect to the shaker table to obtain a faster hose wear rate. Since all the evaluations to be performed during this investigation were to be on a relative basis only (one test judged against another test), using an accelerated test was considered to be reasonable.

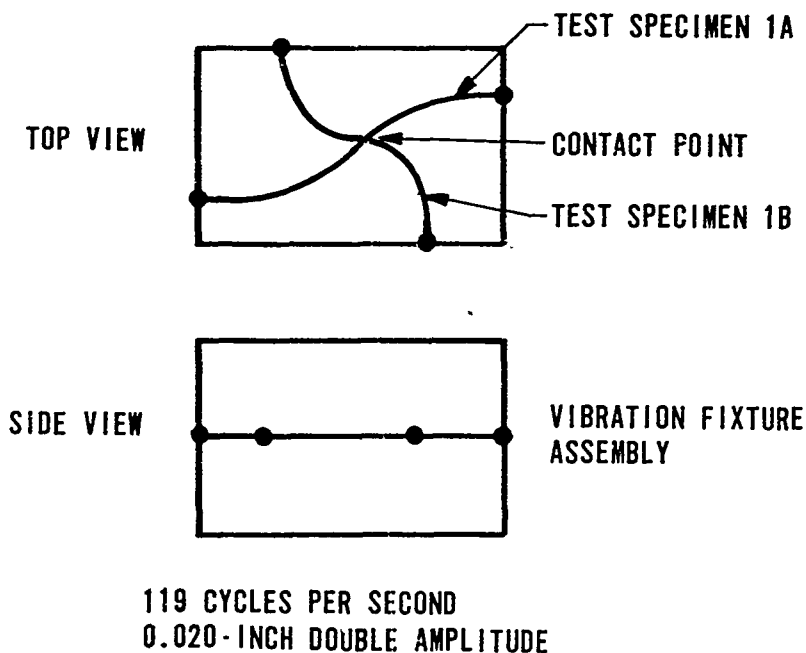

Figure 11. Test Specimens 1A and 1B in Test Orientation.

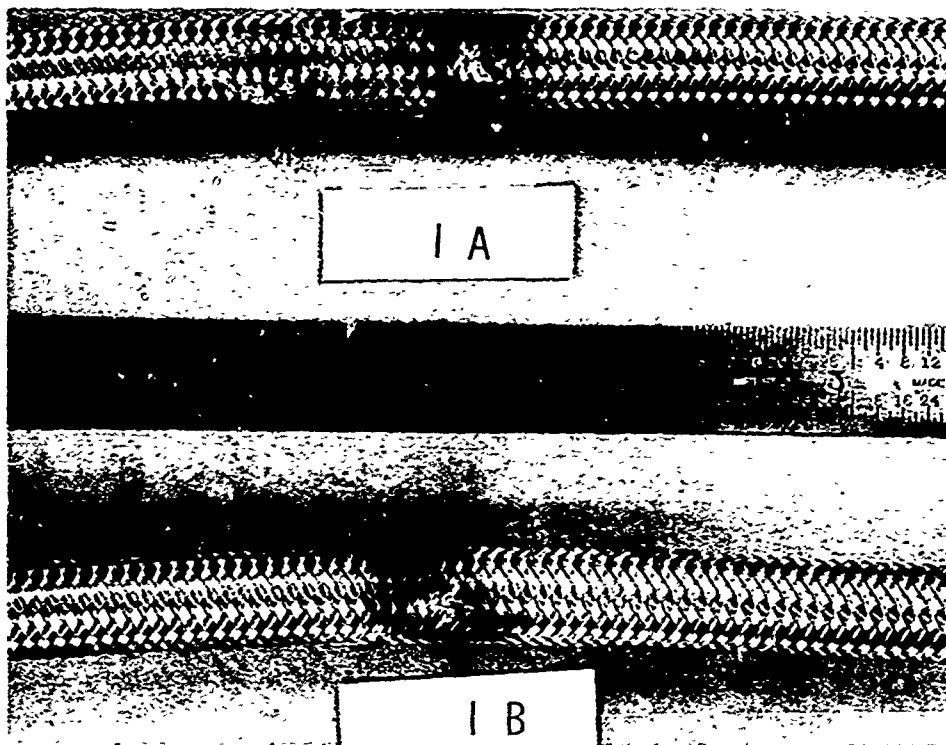

Figure 12. Test Specimens 1A and 1B.

TEST SPECIMENS 2AC AND 2BD THROUGH 19AC AND 19BD

Test specimens 2AC and 2BD through 19AC and 19BD (see Figures 13 through 30) were tested as the test data points for the standard hose-to-hose tests in the orientation shown in Figures 3 and 31. All the hoses for these tests had a 1500-psi internal pressure using static hydraulic fluid (see Figures 4 and 32). It was observed that the first resonant frequency of the hoses was very close to 100 cycles per second input frequency (test specimens 6AC and 6BD through 8AC and 8BD). Therefore, all the remaining data points were vibrated at an input frequency of 100 cps. The shaker table had an input of 0.04-inch double amplitude for all the hoses except 4AC and 4BD. These specimens had a shaker table input of 0.05-inch double amplitude to test for the effects of a larger displacement on the hoses' time to failure. It did not appear that this increase significantly affected the time to failure. Accordingly, a 0.04-inch double-amplitude displacement was used throughout the remaining tests. The data points used to determine a datum MTBF were as follows: 6AC and 6BD through 19AC and 19BD.

Table I shows the data for the standard hose tests. The data were analyzed for the sample mean and standard deviation as outlined below using the data of Tables I and IV:

$$\text{Sample size} = n = 14$$

$$\text{Sample mean} = \bar{X} = \frac{1}{n} \sum_{i=1}^n X_i = \frac{1496.9}{14} = 106.92 \cong 107$$

$$\text{Sample variance} = s^2 = \frac{1}{n-1} \sum_{i=1}^n (X_i - \bar{X})^2; s^2 = 4641.76$$

$$\text{Sample deviation} = s = 68.13$$

Since this test is an investigation of the wear characteristics of wire-braided hoses, it can be assumed that the hoses fail according to a normal distribution. The normal distribution most accurately describes failures due to wear. For a random sample of size n from a normal distribution, $(\bar{X} - \mu) n/s$ has a t distribution with $n-1$ degrees of freedom. Therefore, for a given sample, a probability of $1-\alpha$ for a random variable $\frac{\bar{X} - \mu}{s/\sqrt{n}}$ will assume a value between $-t_{\alpha/2, n-1}$ and $t_{\alpha/2, n-1}$ where $t_{\alpha/2, n-1}$ is the 100 $\alpha/2$ percentage point of the t distribution with $n-1$ degrees of freedom.

$$\text{Pr} \left[t_{1-\alpha/2, n-1} < \frac{\bar{X} - \mu}{s/\sqrt{n}} < t_{\alpha/2, n-1} \right] = 1-\alpha$$

$$\text{Pr} \left[\bar{X} + (t_{1-\alpha/2, n-1}) s/\sqrt{n} < \mu < \bar{X} + (t_{\alpha/2, n-1}) s/\sqrt{n} \right]$$

$$= 1-\alpha = \text{confidence}$$

where $(t_{\alpha/2, n-1}) s/\sqrt{n} = E = \text{allowable error}$ and $-t_{\alpha/2, n-1}$

$$= t_{1-\alpha/2, n-1}$$

TABLE IV. MTBF OF STANDARD WIRE-BRAIDED HOSES

Test	Time to Failure (min)	Test Specimens
1	104.0	6AC and 6BD
2	156.0	7AC and 7BD
3	194.0	8AC and 8BD
4	161.0	9AC and 9BD
5	42.0	10AC and 10BD
6	26.5	11AC and 11BD
7	100.0	12AC and 12BD
8	107.0	13AC and 13BD
9	109.0	14AC and 14BD
10	18.4	15AC and 15BD
11	15.4	16AC and 16BD
12	249.5	17AC and 17BD
13	115.5	18AC and 18BD
14	98.6	19AC and 19BD
$\text{MTBF} = \frac{\Sigma \text{Time to Failure}}{14} = 106.8$		Sample mean and MTBF are equal

α	Confidence $1-\alpha$	$t_{\alpha/2, n-1} = t_{\alpha/2, 13}$	E	Interval (min) $\bar{X} - E < \mu < \bar{X} + E$
0.01	0.99	3.012	54.84	52.16 < μ < 161.84
0.05	0.95	2.160	39.33	67.67 < μ < 146.33
0.10	0.90	1.771	32.25	74.75 < μ < 139.25
0.20	0.80	1.356	24.69	82.31 < μ < 131.69

Therefore, the above data indicate that the population means of the hoses tested will lie within the above time-to-failure intervals for the various confidence levels for any sample of 14 hoses tested by the method used in this report. The relative frequency histogram (Figure 33) and Table V show this premise.

Interval (hr)	Frequency of Occurrence	Relative Frequency	Cumulative Total
0-20	2	0.14	0.14
21-40	1	0.07	0.21
41-60	1	0.07	0.28
61-80	0	0	0.28
81-100	2	0.14	0.42
101-120	4	0.29	0.71
121-140	0	0	0.71
141-160	1	0.07	0.78
161-180	1	0.07	0.85
181-200	1	0.07	0.92
201-220	0	0	0.92
221-240	0	0	0.92
241-260	1	0.07	0.99
TOTALS	14	0.99	0.99

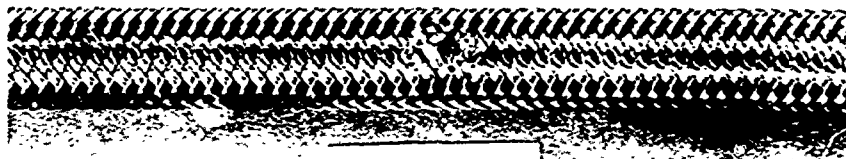

2BD

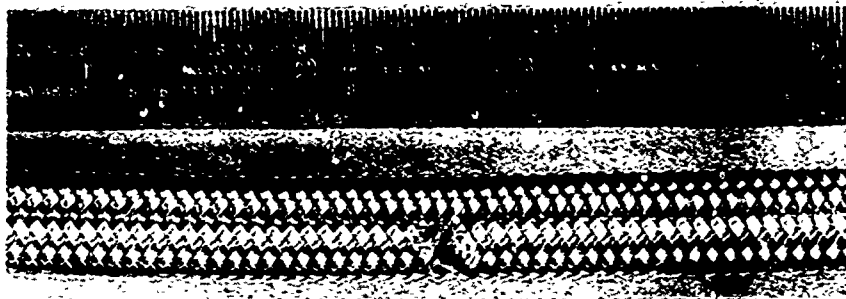

2AC (Failed)

Figure 13. Test Specimens 2AC and 2BD.

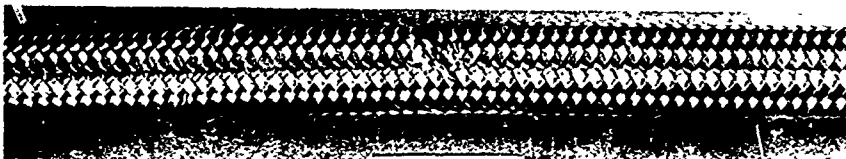

3BD

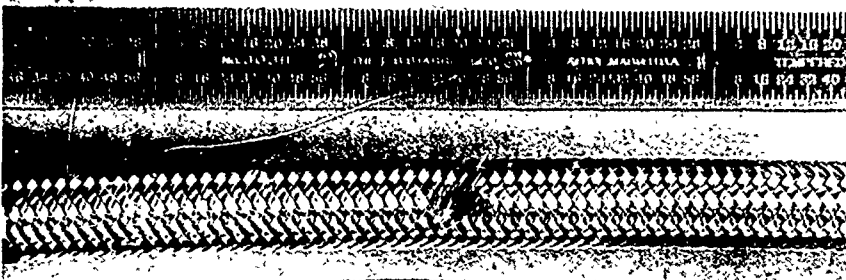

3AC (Failed)

Figure 14. Test Specimens 3AC and 3BD.

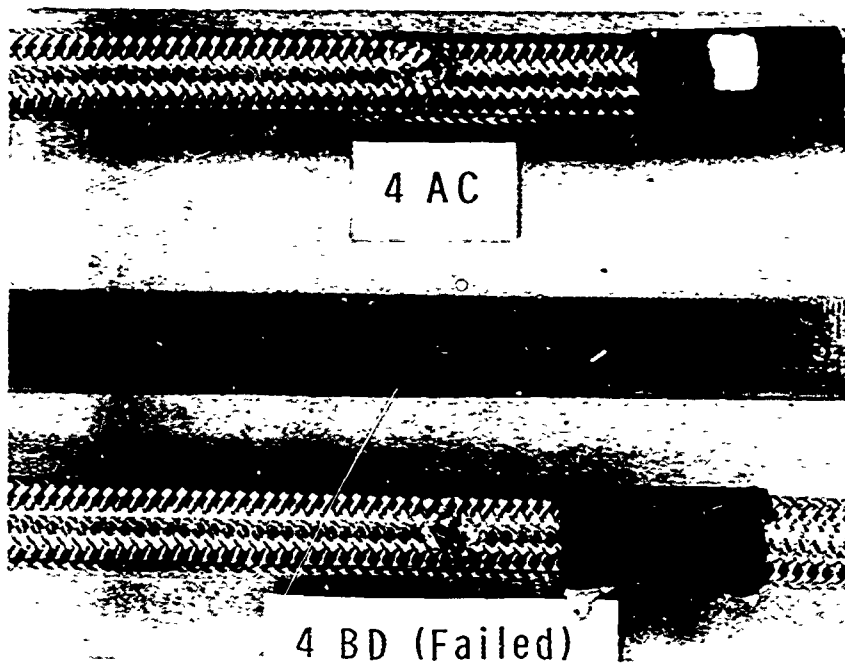

Figure 15. Test Specimens 4AC and 4BD.

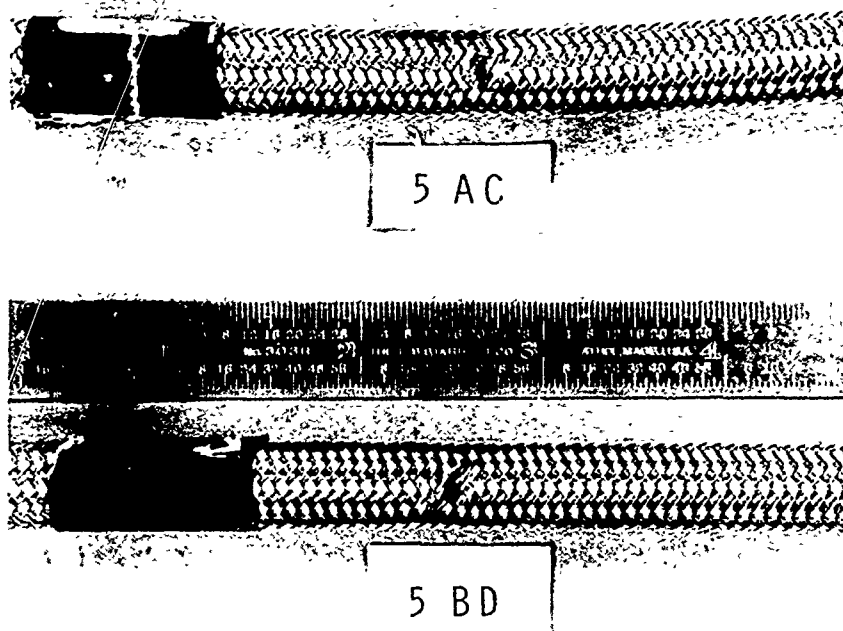

Figure 16. Test Specimens 5AC and 5BD.

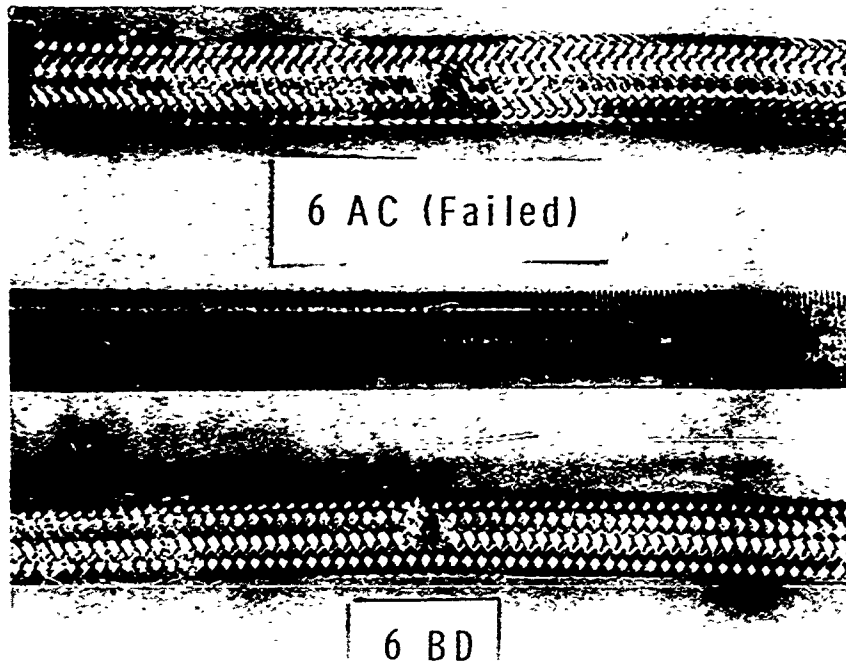

Figure 17. Test Specimens 6AC and 6BD.

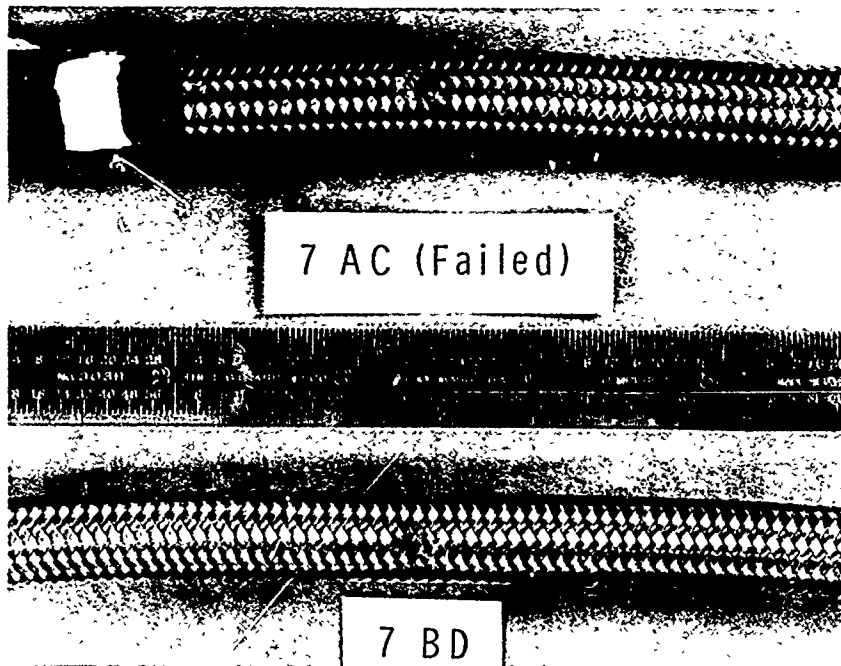

Figure 18. Test Specimens 7AC and 7BD.

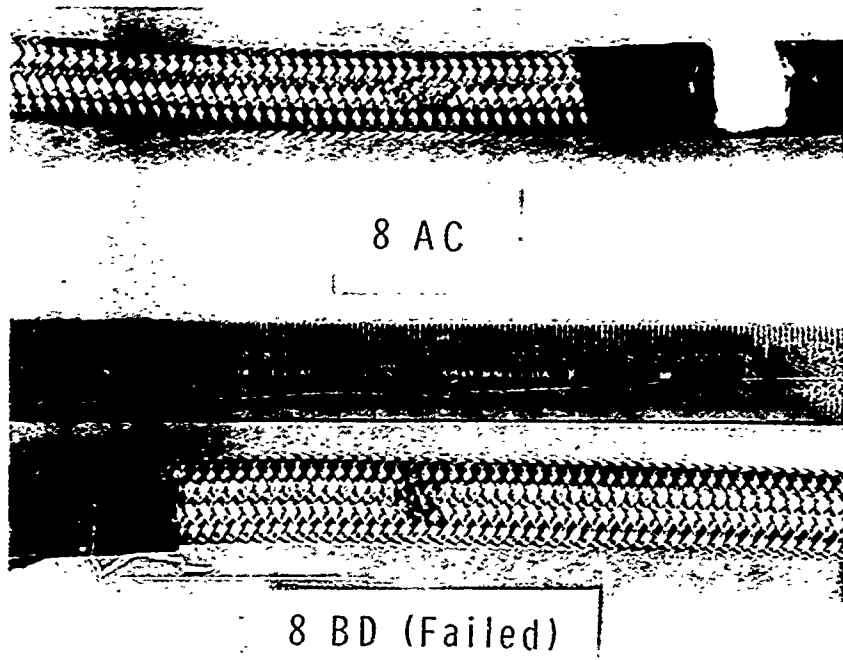

Figure 19. Test Specimens 8AC and 8BD.

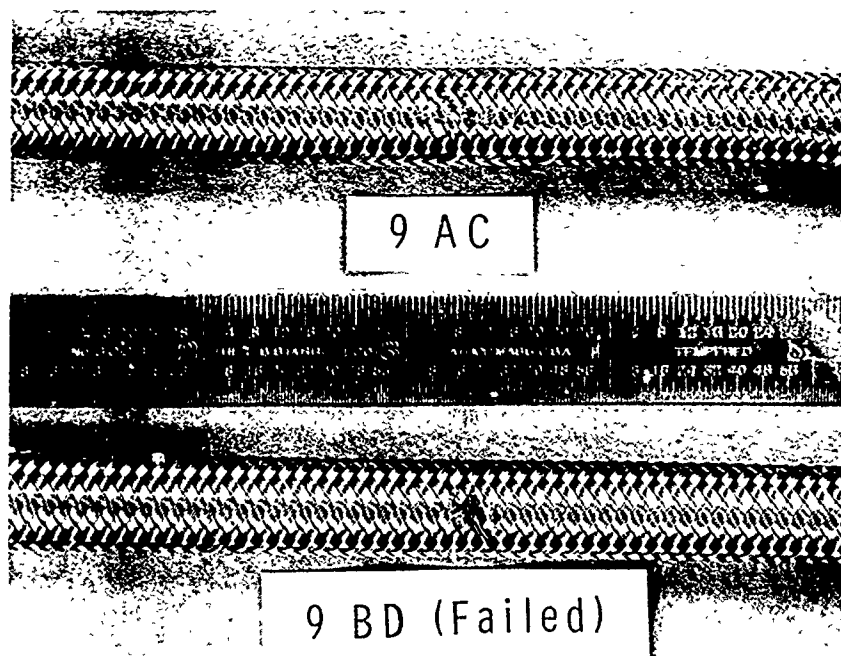

Figure 20. Test Specimens 9AC and 9BD.

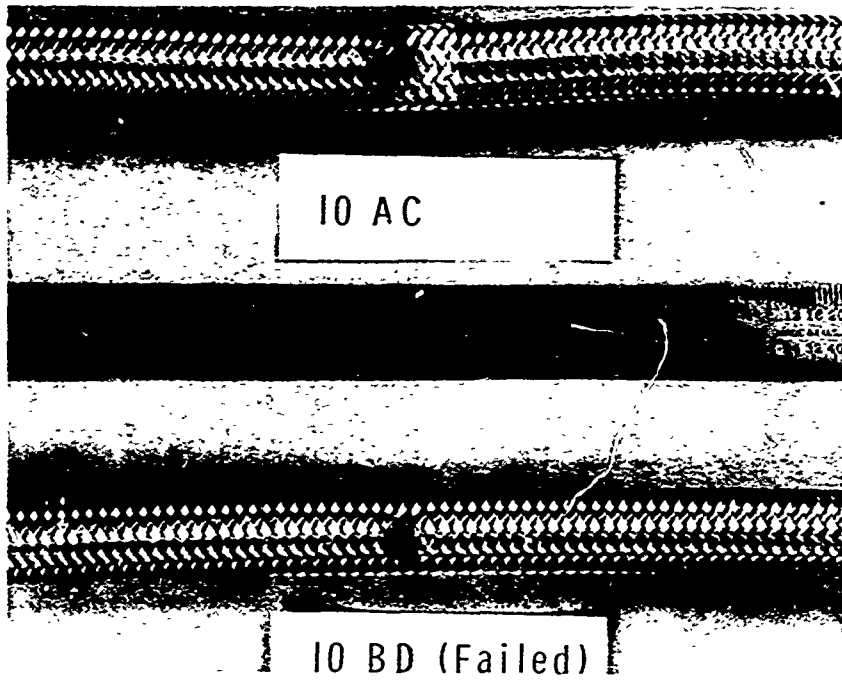

Figure 21. Test Specimens 10AC and 10BD.

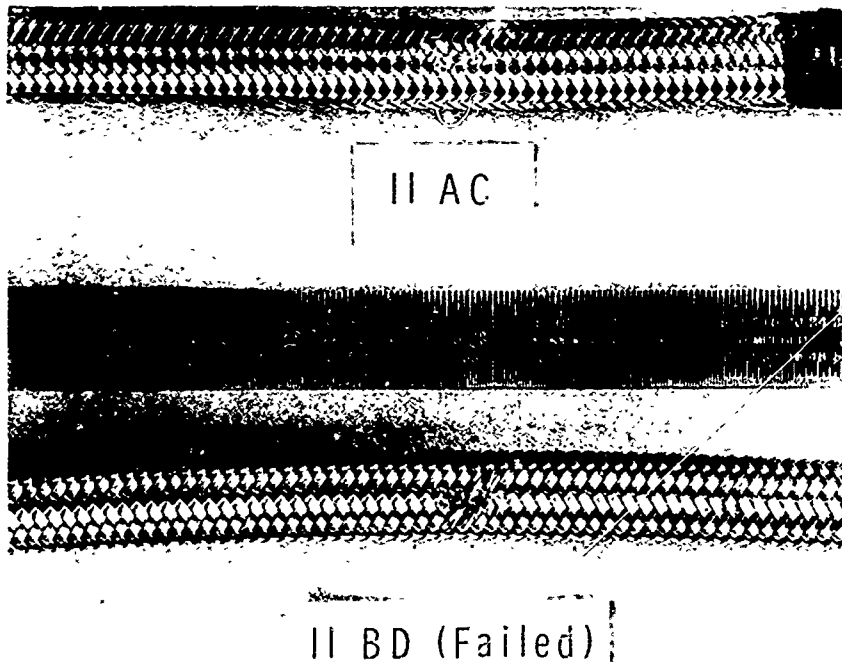

Figure 22. Test Specimens 11AC and 11BD.

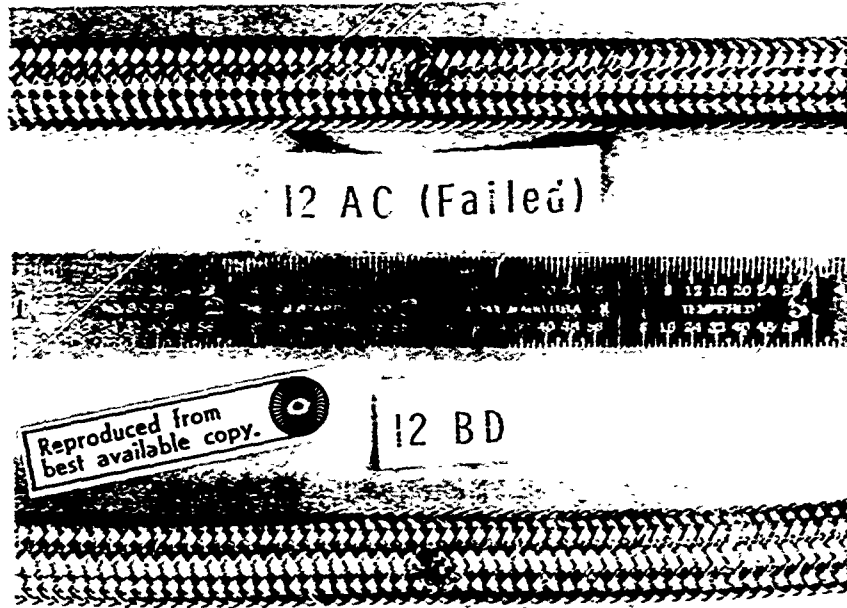

Figure 23. Test Specimens 12AC and 12BD.

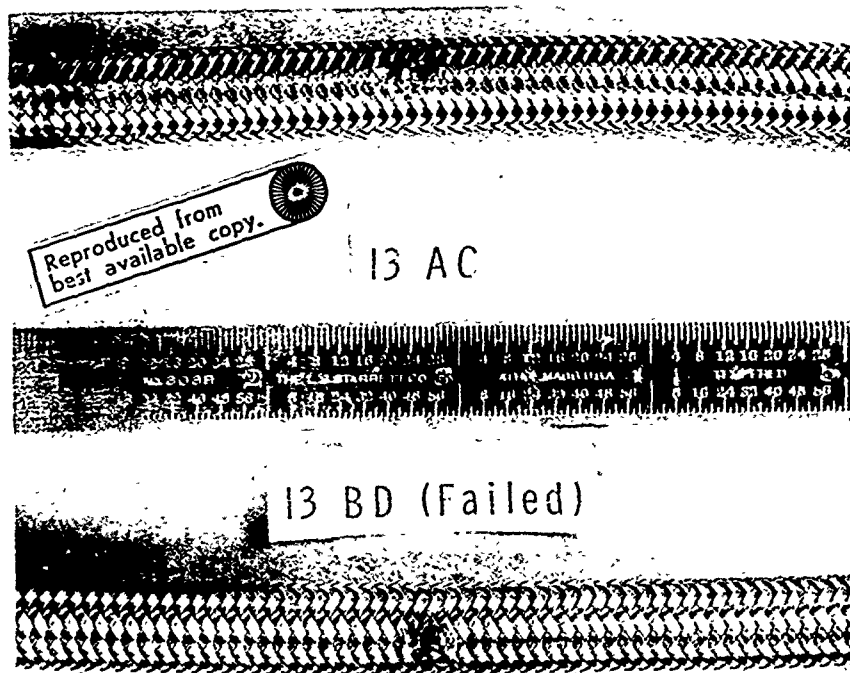

Figure 24. Test Specimens 13AC and 13BD.

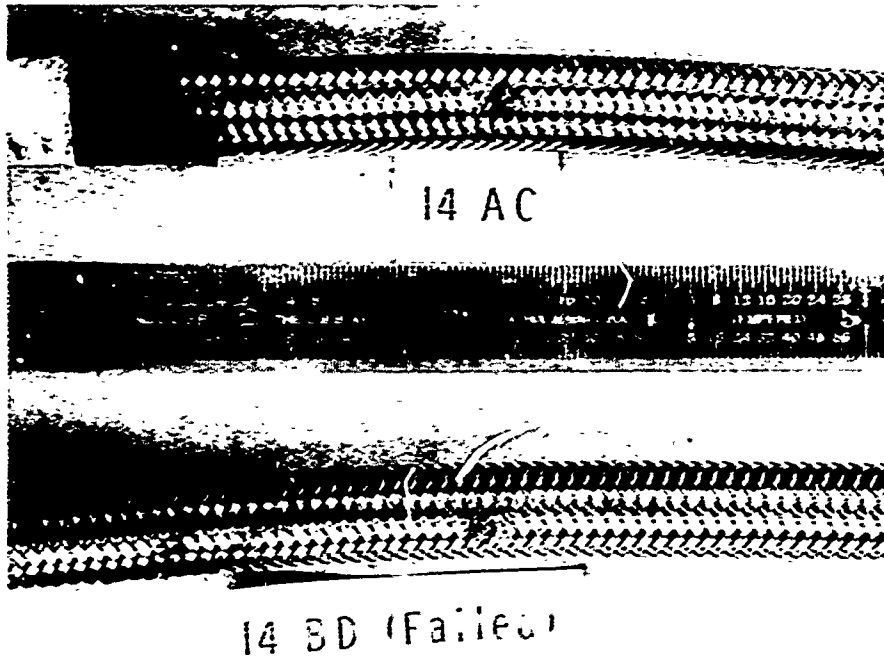

Figure 25. Test Specimens 14AC and 14BD.

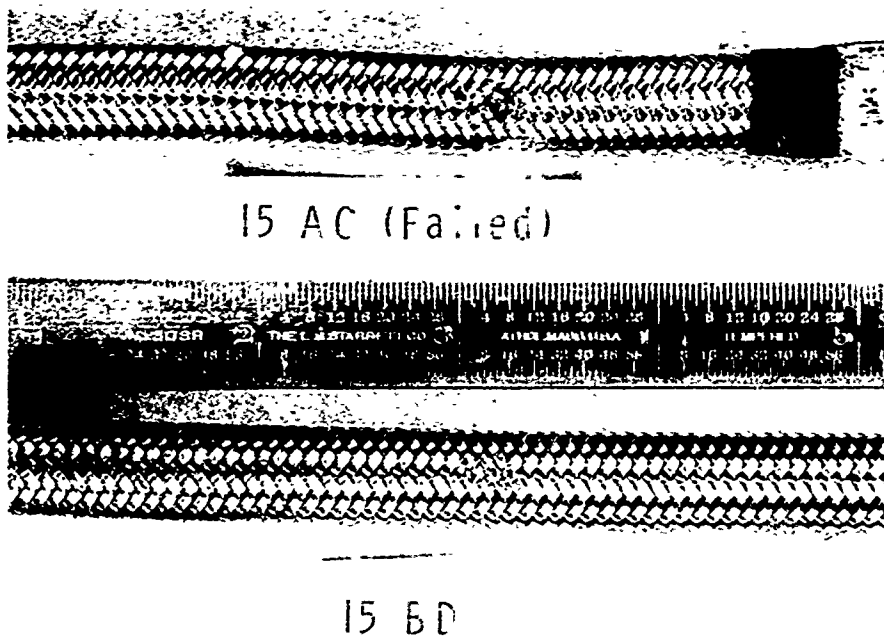

Figure 26. Test Specimens 15AC and 15BD.

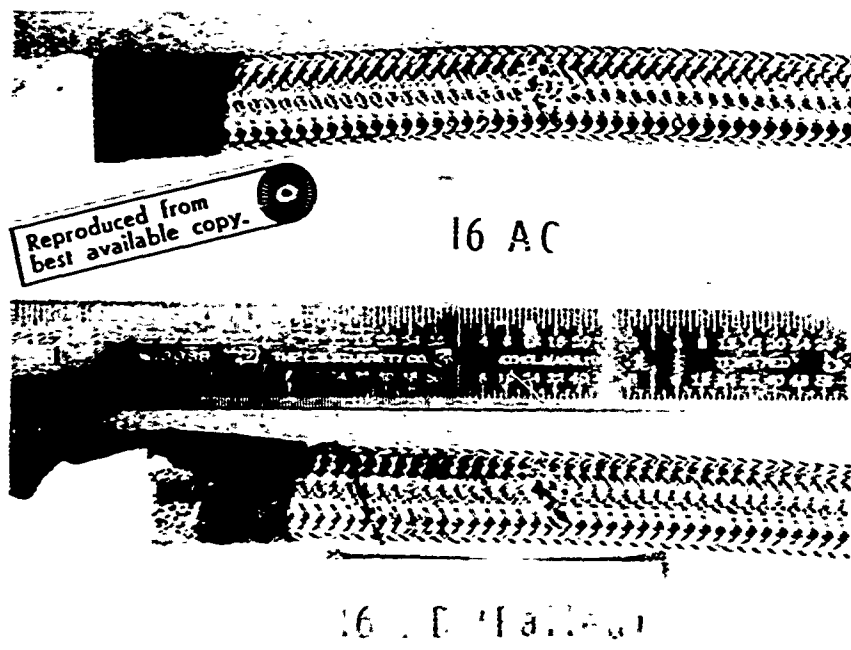

Figure 27. Test Specimens 16AC and 16BD.

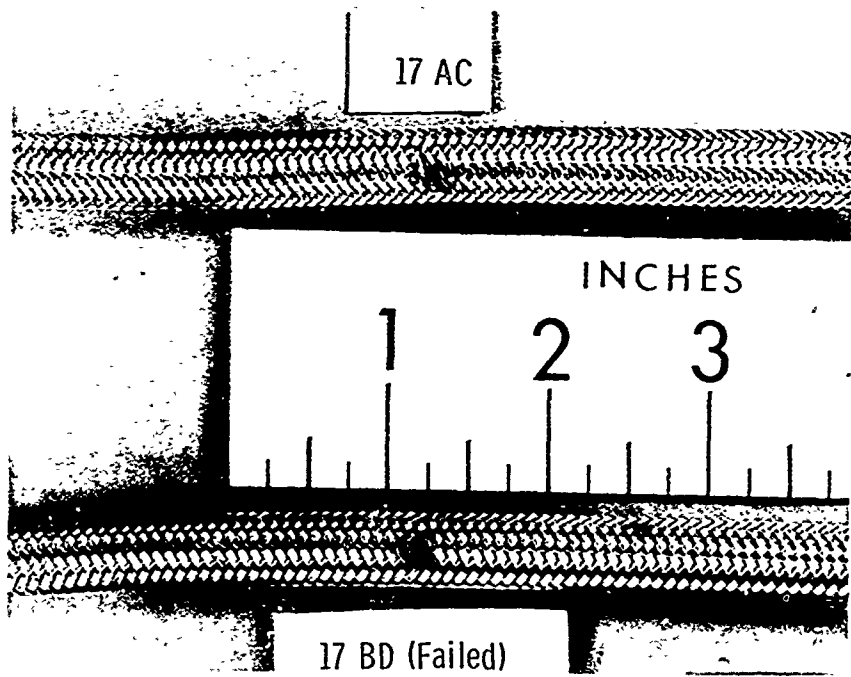

Figure 28. Test Specimens 17AC and 17BD.

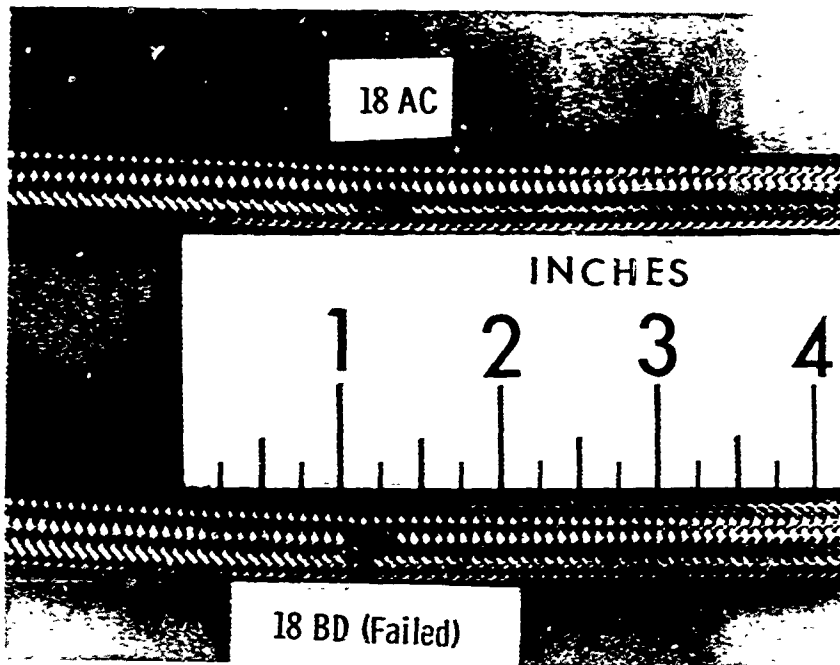

Figure 29. Test Specimens 18AC and 18BD.

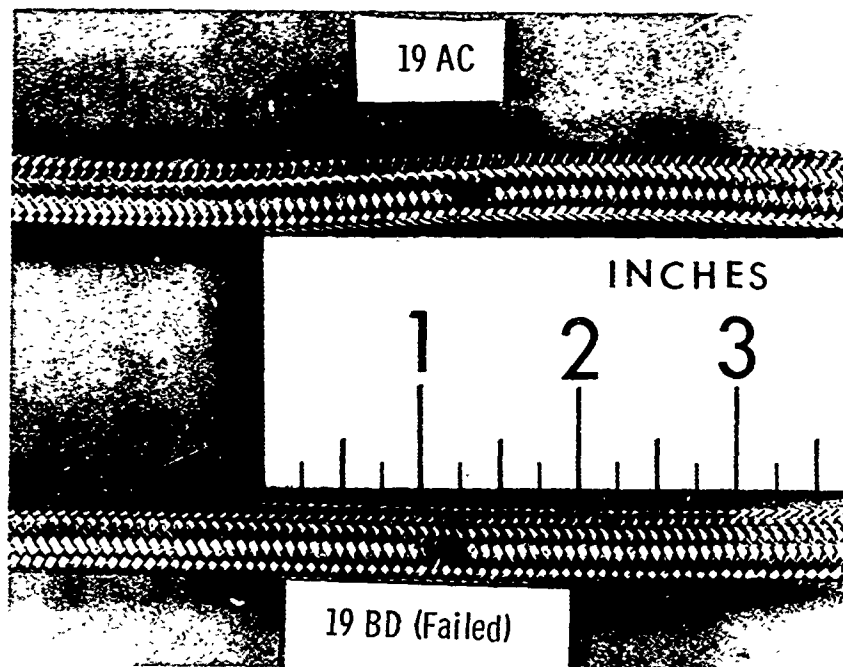

Figure 30. Test Specimens 19AC and 19BD.

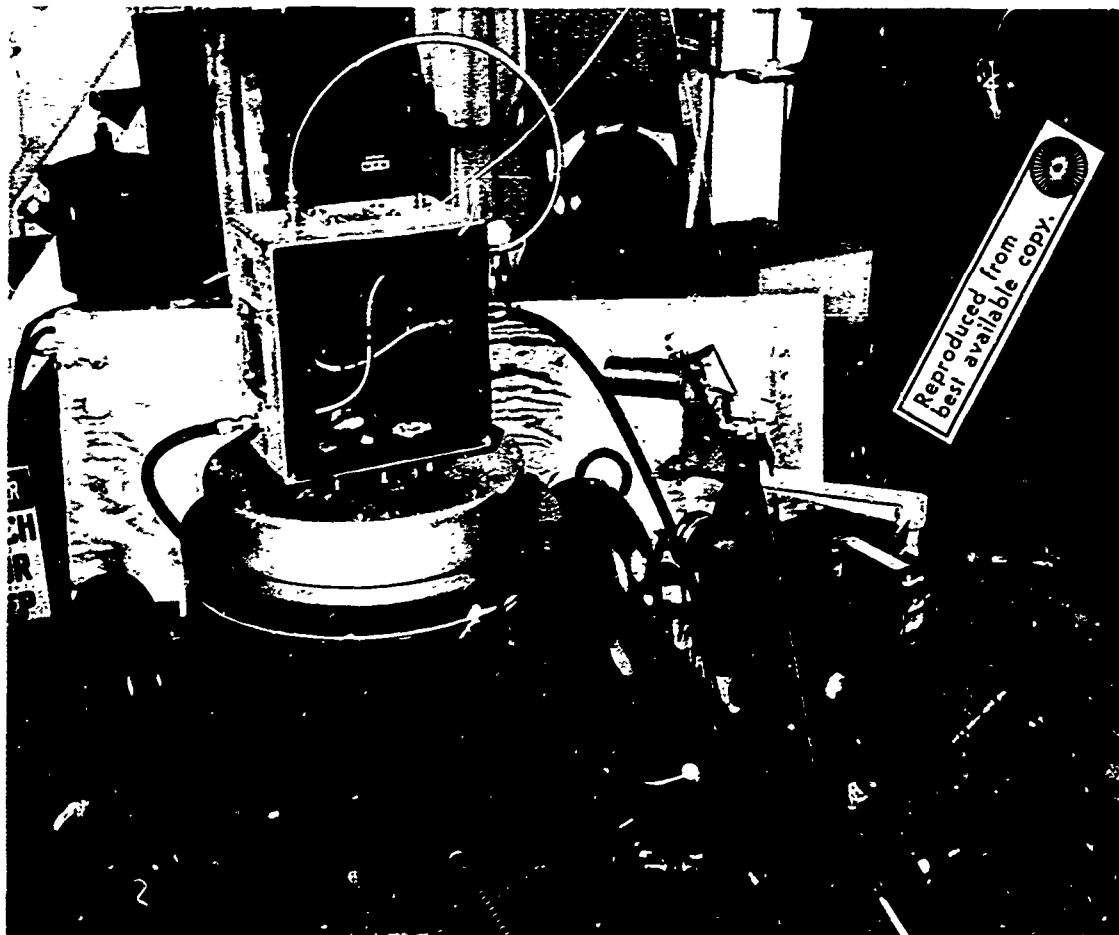
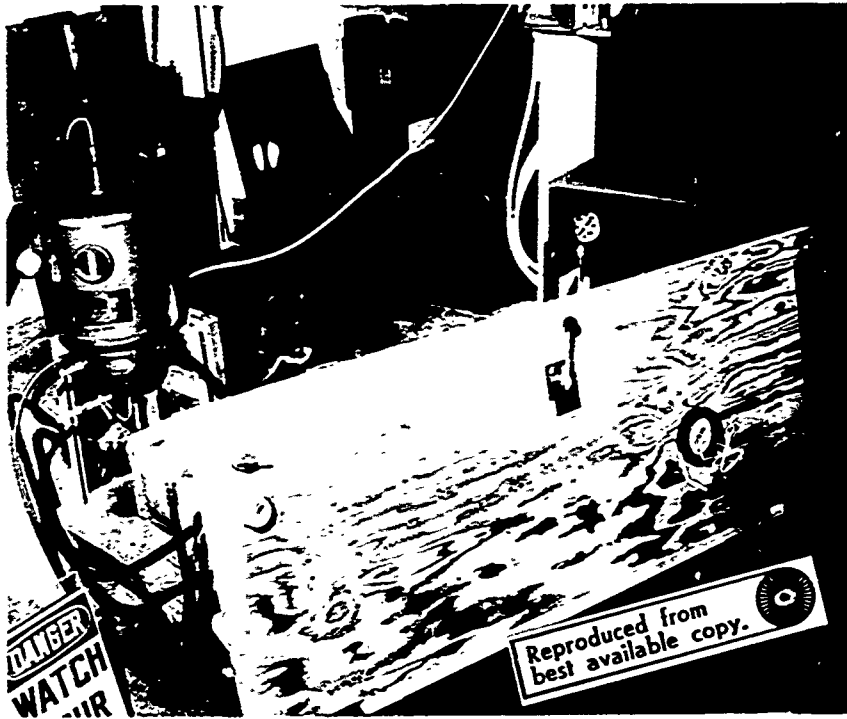
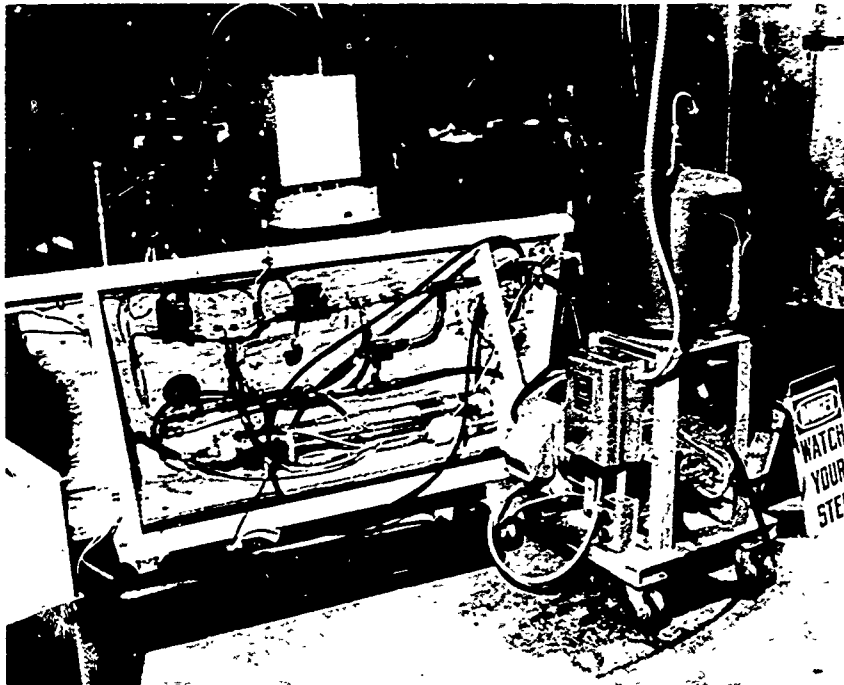

Figure 31. Vibration Fixture Assembly.



a. Front View



b. Rear View

Figure 32. Hydraulic Assembly.

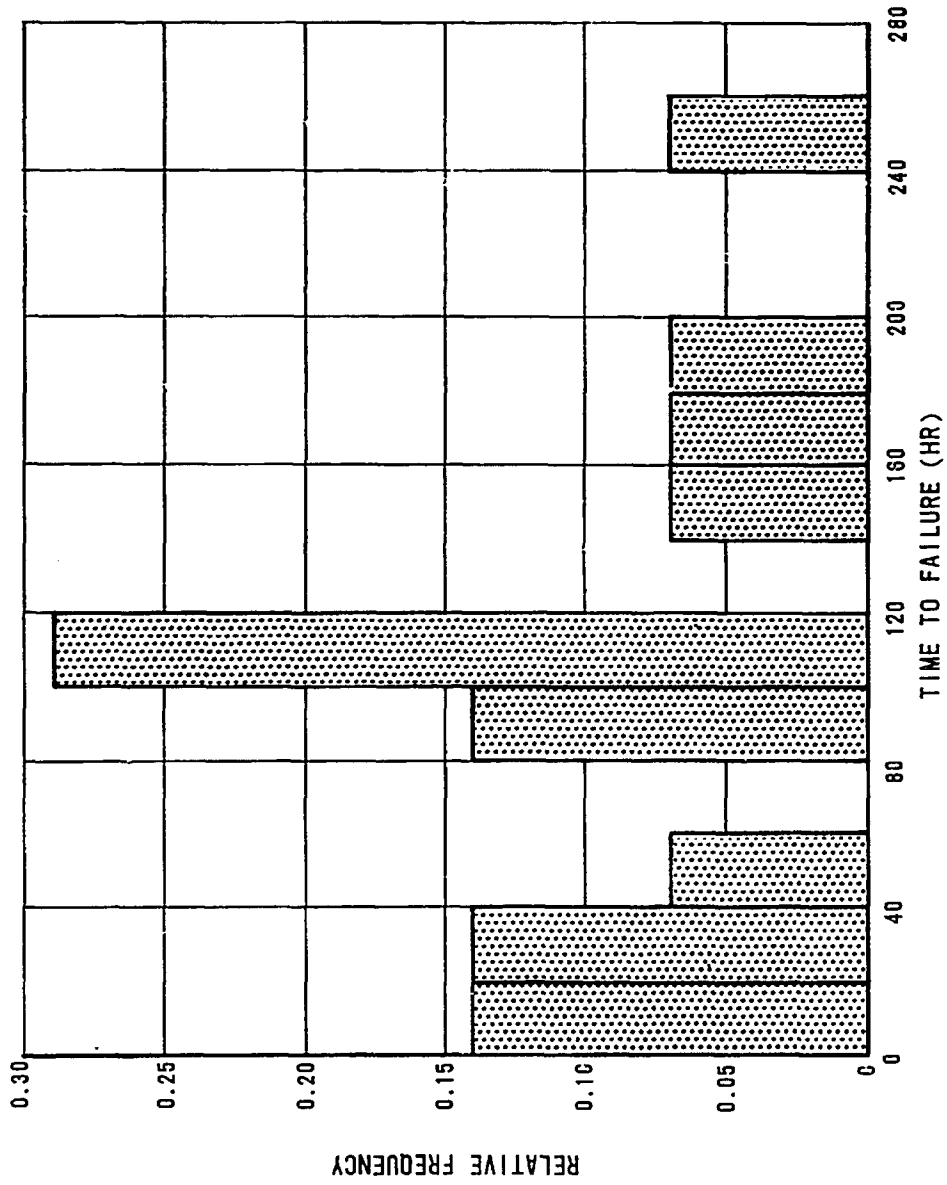

Figure 33. Relative Frequency Histogram.

APPENDIX III
MODIFICATION OF STANDARD HOSES
TO IMPROVE HOSE CHAFING CHARACTERISTICS

Laboratory tests were conducted to evaluate the effect of covering or securing wire-braided hoses to preclude chafing. Since the test time for each set of hoses examined had to be limited to some reasonable value, 100,000 seconds (or 1666.7 minutes) was selected. Any covering or securing method that prevented or precluded chafing of the wire-braided hose for at least 1666.7 minutes under the same conditions as the standard hose test (see Appendix II) was termed a success. Hence, there are generally no values of test time greater than 1666.7 minutes.

The following rationale was used to establish the maximum test termination time of 100,000 seconds:

1. The assumptions used were: a rotor revolution of 300 rpm, a single rotor such that there was one cycle per revolution per blade as the fundamental vibration to be expected, two blades per rotor, and potential operating time exceeding the 100-hour periodic inspection time by at least 2.5 (i. e. , a 250-hour operating time without failure).
2. Approximately 3,600,000 cycles are imparted to the airframe between 100-hour inspections by the main rotor due to the fundamental vibration assumed above (300 rpm/blade = 5 cycles/second/blade = 10 cycles/second for two blades; 100 hours = 360,000 seconds; 360,000 seconds \times 10 cycles/second = 3,600,000 cycles).
3. Using the 2.5 criterion assumed above, at least 9,000,000 cycles need to be demonstrated by test (2.5 \times 100 hours = 250 hours = 900,000 seconds; 900,000 seconds \times 10 cycles/second = 9,000,000 cycles).
4. As an additional safety factor, 1,000,000 cycles was added to the requirements. Therefore, if the hoses are vibrated through 10,000,000 cycles, they will have been tested for approximately 278 hours of aircraft operating time at the conditions of this investigation (20g acceleration = $0.0511f^2D = 0.0511(100)^2 \times 0.04$). Therefore, the maximum test time was established as 100,000 seconds = 10,000,000 cycles/100 cycles/second, where

100 cycles/second was the resonant frequency of the hoses in the orientation shown in Figure 3. The resonant frequency was used to achieve the maximum displacement of the hoses during the tests.

5. A test termination condition of 10,000,000 cycles at a 20g acceleration was considered to be the upper or maximum factor for these tests. Therefore, the protected, or covered, hoses were vibrated at the same shaker table input conditions as the unprotected hoses to maintain a consistent relationship between cycles and time to failure or test termination time.

Following is a description of those materials and test specimens that were examined to determine their ability to improve the standard wire-braided hose mean time to failure due to chafing; test results are recorded in Table VI (the capital letters following the test specimen number identify the position that the specimen occupied during the test, as shown in Figure 3).

1. Test specimens 23AC and 23BD were tested using wire-braided hose covered with a nylon 6 spiral-cut tubing of OD 0.500 ± 0.020 inch and a wall thickness of 0.060 inch. The cost of the coil was 45 cents per foot. The hoses were vibrating in the same orientation as the standard or unprotected hoses, and after 608.3 minutes the hoses and covering were examined for wear. The nylon coils were found to be attached to one another, possibly due to a friction weld (see Figure 34). No further tests of 0.060-inch-thick nylon coil were made. Only spiral-cut nylon 6 and 6/6 coils of 0.030-inch wall thickness were examined further, since that thickness would allow some visual inspection of the hose through the coil for wear, leakage, or twisting.
2. Test specimens 24AC and 24BD were tested using a section of slit-cut plasticized polyvinylchloride tubing of 0.15 inch thickness. After 25.8 minutes, the tubing was observed to be worn to the point where the hoses were touching braid to braid (see Figures 35 and 36). The plasticized polyvinylchloride was dropped from further consideration as a potential "fix" based on the rapid wear rate of this material under these test conditions.
3. Test specimens 25AC and 25BD were examined using a section of tetrafluoroethylene sheet that had been made into a coil of 0.500-inch OD and 0.070-inch wall thickness and wrapped around the hoses individually (see Figure 37). This material

TABLE VI. TEST SPECIMEN DATA FOR MODIFIED STANDARD HOSE TESTS*

Specimen Number	Time to Test Termination (min)	Notes/Comments
23AC/23BD	608.3	Nylon bonded together at end of test; unknown time to bonding action; 0.060 in. thick
24AC/24BD	25.8	Plasticized polyvinylchloride tubing melted due to friction
25AC/25BD	1666.7	Laboratory-made tetrafluoroethylene coil; contact force = 4.75 lb
26AC/26BD	1666.7	Nylon 6 coil; 0.030 in. thick
27AC/27BD	1666.7	Same as 26AC/26BD
28AC/28BD	1690.0	Same as 26AC/26BD
29AC/29BD	1695.0	Tetrafluoroethylene coil; 0.035 in. thick; contact force = 4.50 lb
30AC/30BD	1666.7	Tied together with steel wire; contact force >> 4.50 lb
31AC/31BD	1725.0	Nylon 6/6 coil; 0.030 in. thick; surface to surface; contact force = 3.75 lb
32AC/32BD	1666.7	Nylon 6/6 coil; 0.030 in. thick; surface to edge; contact force = 4.75 lb
33AC/33BD	1681.6	Nylon 6/6 coil; 0.030 in. thick; edge to edge; contact force = 4.50 lb
34AC/34BD	1784.3	Nylon 6/6 coil; 0.030 in. thick; surface to surface; contact force = 3.75 lb
35AC/35BD	1784.3	Nylon 6/6 coil; 0.030 in. thick; surface to edge; contact force = 5.0 lb
36AC/36BD	1694.3	Tetrafluoroethylene tape; single wrap; contact force = 4.50 lb
37AC/37BD	1666.7	Tetrafluoroethylene tape; double wrap; contact force = 4.25 lb
38AC	162.0	0.032-in.-thick aluminum sheet; vibrated unprotected hose against sheet; contact force = 0.75 lb
39AC	1252.7	0.062-in.-thick aluminum sheet; vibrated unprotected hose against sheet; contact force = 1.0 lb
40AC	1291.7	Unprotected hose vibrated within a No. 7 Adel clamp with the rubber insert removed
41AC	1225.8	Unprotected hose vibrated within a No. 6 Adel clamp with the rubber insert removed
42AC	1666.7	Unprotected hose vibrated within a No. 8 Adel clamp with the rubber insert in place; the whole arrangement covered with hydraulic fluid and sand

*Tested at a shaker input frequency of 100 Hz and 0.04-inch double amplitude.

lasted the maximum time (1666.7 minutes), but there was considerable chipping of the tetrafluoroethylene caused by the braid rubbing against the coil and the two edges of the tetrafluoroethylene coil rubbing together. No additional tetrafluoroethylene coils were made in the laboratory for testing in the program; however, one additional commercially made tetrafluoroethylene coil was tested (see paragraph 5 describing specimens 29AC and 29BD).

4. Test specimens 26AC, 26BD, 27AC, 27BD, 28AC, and 28BD were tested for suitability of nylon 6 (polycaprolactum). The material was spiral-cut tube with a 0.500-inch outside diameter and a 0.030-inch wall thickness. It has an operating temperature of -100°F to $+250^{\circ}\text{F}$ with a distance between the spiral cut of 0.562 inch (cost, 45 cents per foot). All three test specimens were bonded together until each test was terminated. An investigation was conducted of the effect of an edge of the nylon coil chafe guard on the time to failure of nylon-wrapped wire-braided hose vibrating as shown in Figure 3. Figures 38, 39, and 40 show how the nylon coil edges and surfaces were varied with respect to one another. The orientation of the edges and surfaces of the nylon 6 samples did not affect the abrasion characteristics of the test samples.
5. Test specimens 29AC and 29BD were tested for the suitability of tetrafluoroethylene. The material was spiral cut with a 0.500-inch outside diameter and a 0.035-inch wall thickness. It has a continuous operating temperature of -400°F to $+500^{\circ}\text{F}$ with a distance between the spiral cut of 0.562 inch (cost, \$4.20 per foot for orders less than 100 feet, to \$2.53 per foot for orders greater than 10,000 feet). Both sets of specimens wore at the contact point during the test, but both appear to satisfy the requirement for a chafe guard, since the specimens did last the required test time. However, the tetrafluoroethylene material was precluded from further testing because it was suspected that it would be eliminated from consideration by aircraft designers for three reasons: its relatively high cost (compared to nylon), its poor ability to retain its original shape when removed from a hose (hence, it could not be reused); and its faster abrasion than the nylon coil under the same test conditions. Figures 40 and 41 show the difference in wear between nylon coil and tetrafluoroethylene coil.
6. Test specimens 30AC and 30BD were tied together with zinc-coated annealed steel wire. The wire was 0.032 inch thick,

meeting Federal Specification QQ-W-461-8. With no covering placed on the hoses, six strands of wire were manually wrapped around the hoses at their point of contact (see Figure 3) similar to the way aircraft safety wiring is installed. No wear of the hoses could be detected after cycling these specimens the full test time. This verified the belief that binding of hoses together tightly enough to preclude relative motion eliminates wear between the hoses. In addition, the resonant frequency of the hoses in this mode was checked and found to be 99.5 cycles per second. Therefore, in this case, binding the hoses together did not significantly change the resonant frequency from the unbound case (see Appendix II). Figure 42a shows the hoses bound together before the test, and Figure 42b shows each hose at completion of the test.

7. Test specimens 31AC and 31BD through 35AC and 35BD were examined using spiral-cut nylon 6/6 (polyhexamethylene adipamide) coil. The material was 0.030 inch thick with a distance between cuts of 0.562 inch and an outside diameter of 0.500 inch. It has an operating temperature of -100°F to $+250^{\circ}\text{F}$. None of the specimens bonded together during the tests, as had the previous nylon specimens (26AC, 26BD through 28AC, 28BD). Little wear was noted, but discoloration occurred at the point of contact (see Figures 43 through 47). This color change might be useful to indicate a rubbing or chafing condition. Nylon 6/6 is relatively inexpensive (45 cents per linear foot) and is readily available.
8. Test specimens 36AC and 36BD and 37AC and 37BD were examined using wrappings of tetrafluoroethylene electrical insulation tape, part number 5960-848-8683. The tape was 1 inch wide and 0.0056 to 0.0065 inch thick. It is relatively cheap, costing 26 cents per linear foot. However, the true cost has to be based on the linear feet required to cover equal lengths of wire-braided hose with tape and any other covering being considered. These results indicate that tetrafluoroethylene tape does not provide adequate antichafing characteristics, as shown in Figures 48, 49, and 50. An additional drawback is the adhesive backing. It could break down or run at temperatures above 140°F or become brittle at temperature below -40°F . However, no environmental check was conducted for its temperature characteristics.
9. Test specimens 38AC and 39AC were examined using unprotected

hose rubbing against aluminum sheet. A section of 2024-T4 aluminum of 0.032 inch thickness was used for the 38AC specimen, and a section of 0.060 inch thickness was used for the 39AC specimen. The hose abraded the aluminum until there was no contact between the hose and the sheet aluminum (see Figures 51 and 52). There was no apparent wear of the hose braids during the test. Therefore, it was concluded that potential mode of failure was insignificant. However, wear of the hoses would probably occur if contact were made with an iron-alloyed material aboard an aircraft. Since most of the material aboard an aircraft is made of aluminum alloys, no investigation was conducted to determine wear between the hose and an iron-alloyed material.

10. Test specimens 40AC and 41AC were examined using MS 21919 clamps with the rubber inserts removed. In both cases, the hoses wore through the clamps while sustaining no wear themselves. Although clamps of different sizes were used for each of the two tests, the clamp material was the same for both samples. Testing was terminated as soon as each hose had severed its clamp (see Figures 53 through 55).
11. Test specimen 42AC was tested using an MS 21919 clamp with the rubber insert in place and covered with hydraulic fluid and sand. This sample lasted the maximum test time without any apparent wear to the hose or the clamp (see Figures 56 through 58). Therefore, this mode of failure (potential) was not considered significant with respect to hose chafing.

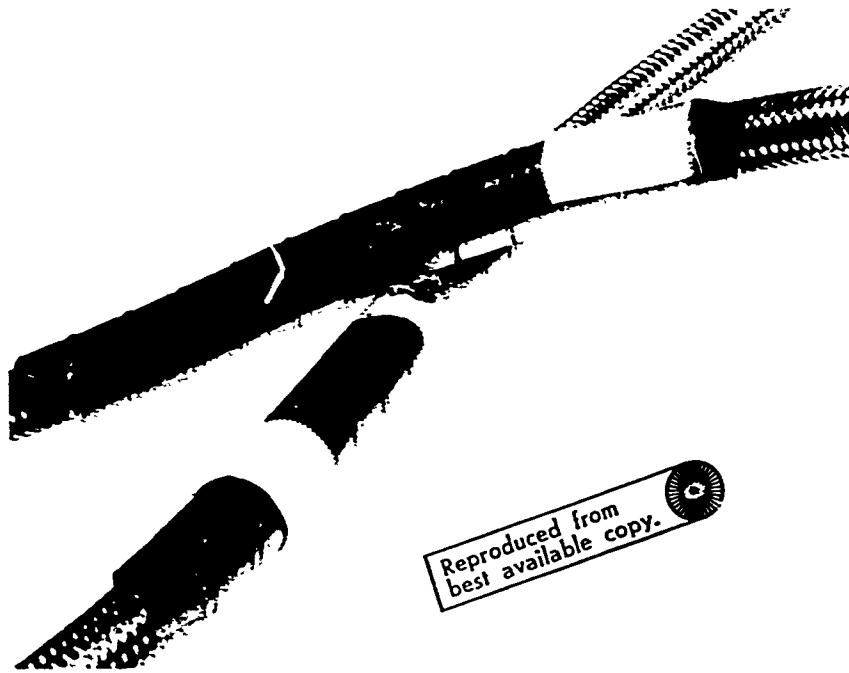

a. Bonded

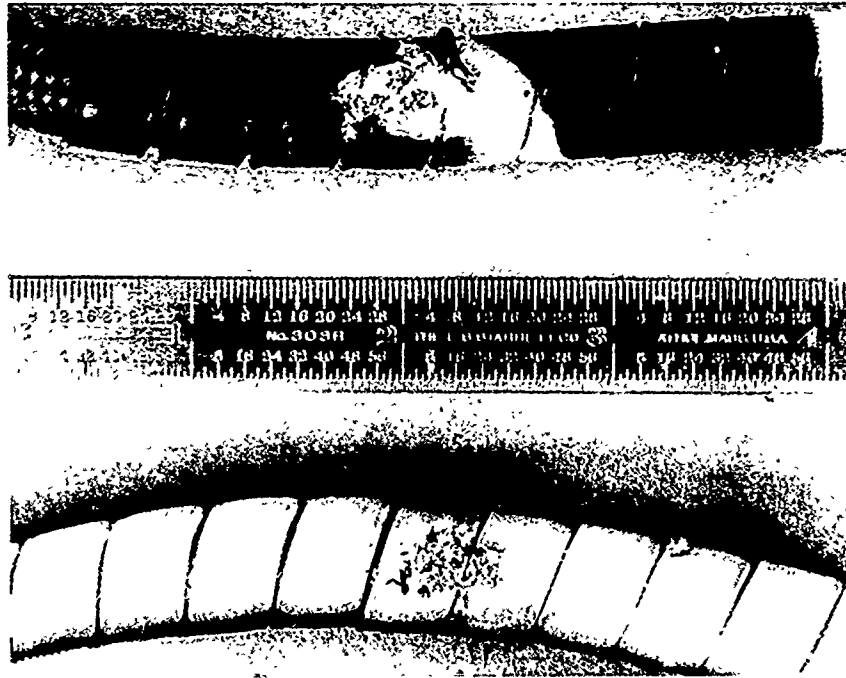

b. Separated

Figure 34. Test Specimens 23AC and 23BD.

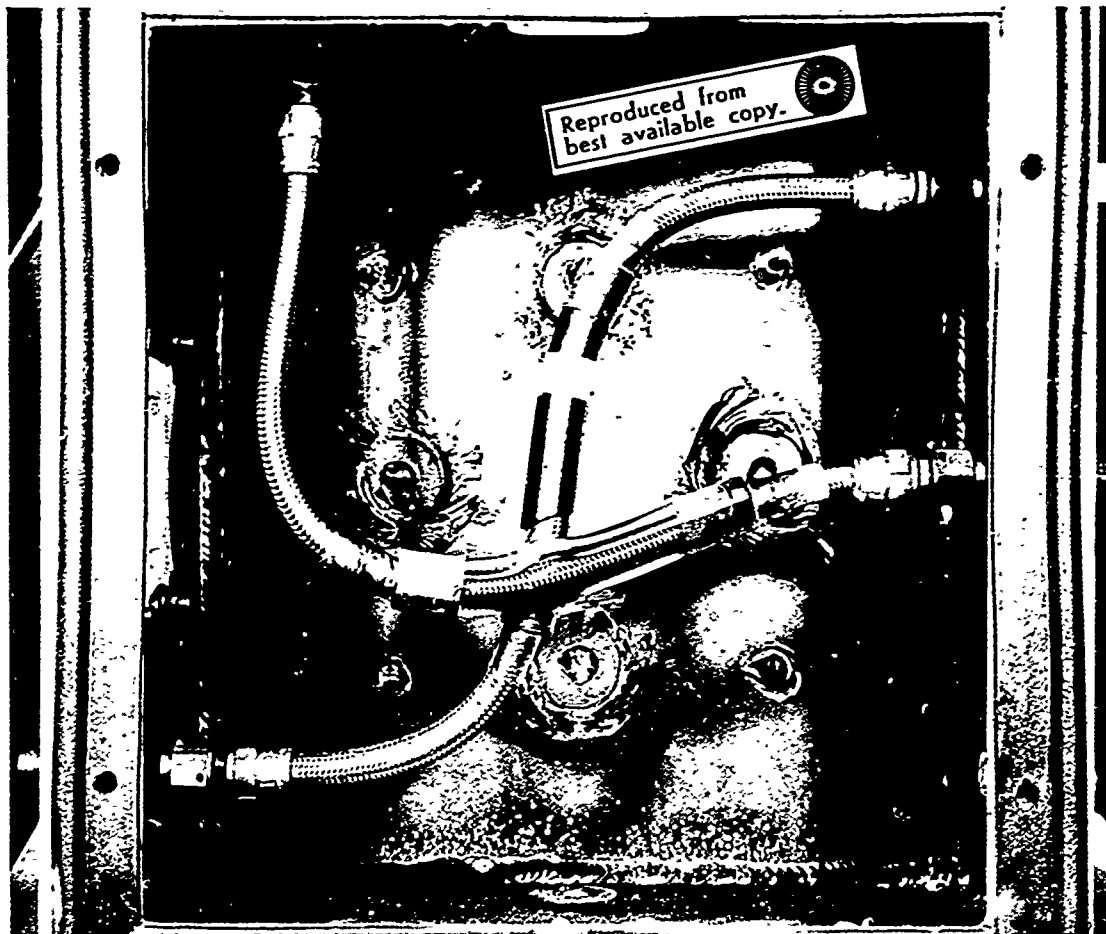
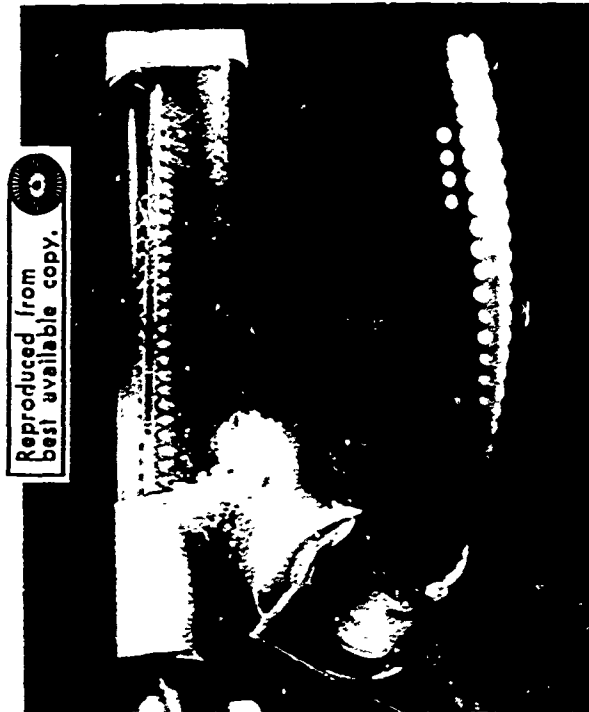
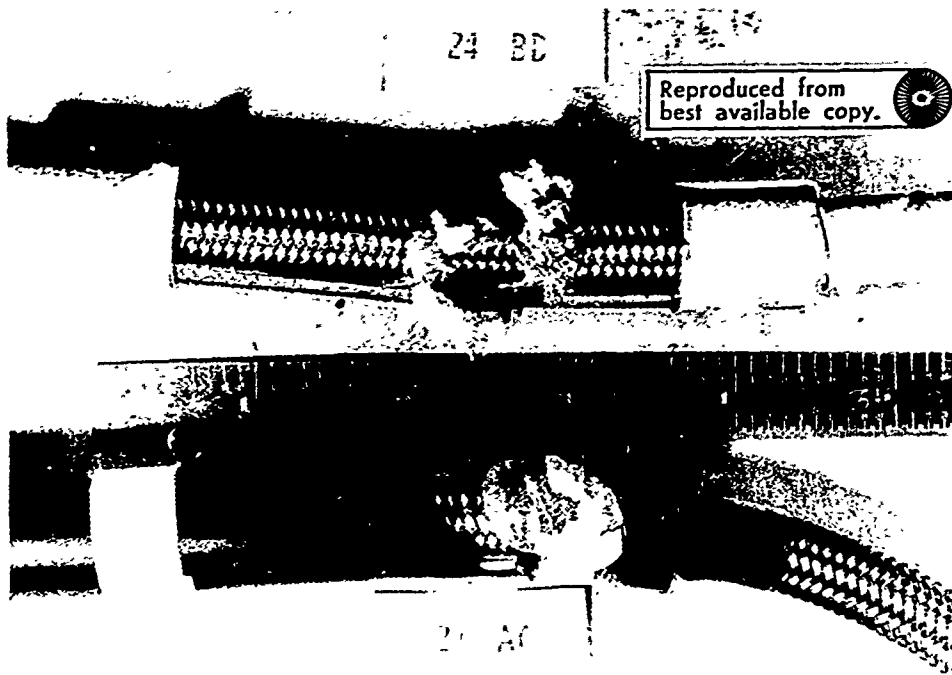

Figure 35. Test Specimens 24AC and 24BD in Test Fixture.



a. Bonded



b. Separated

Figure 36. Test Specimens 24AC and 24BD.

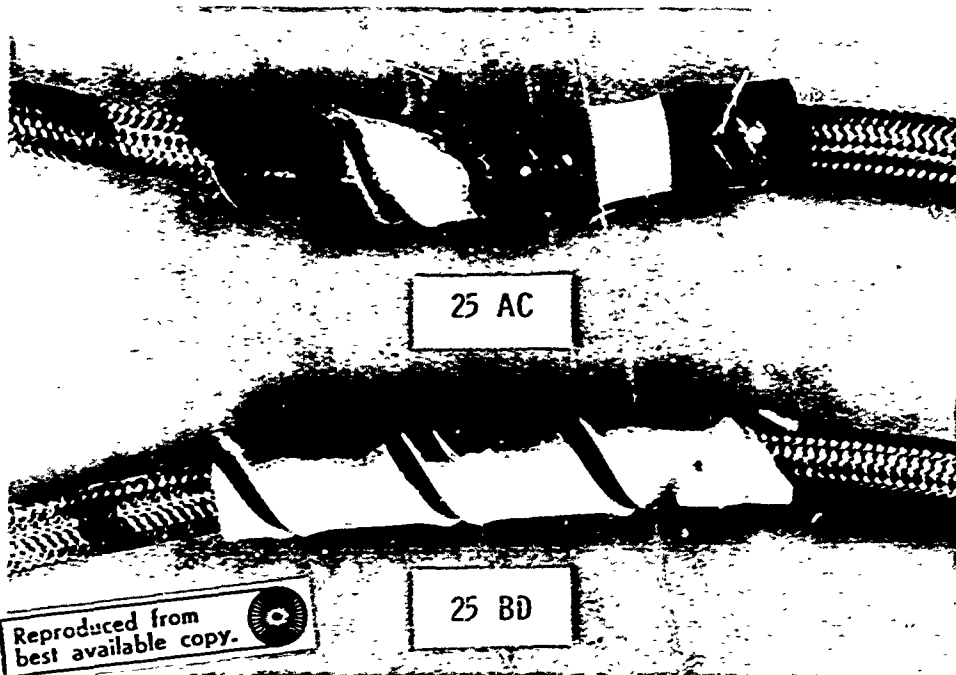

Figure 37. Test Specimens 25AC and 25BD (Tetrafluoroethylene Wrapping, 100,000 Seconds Test Time).

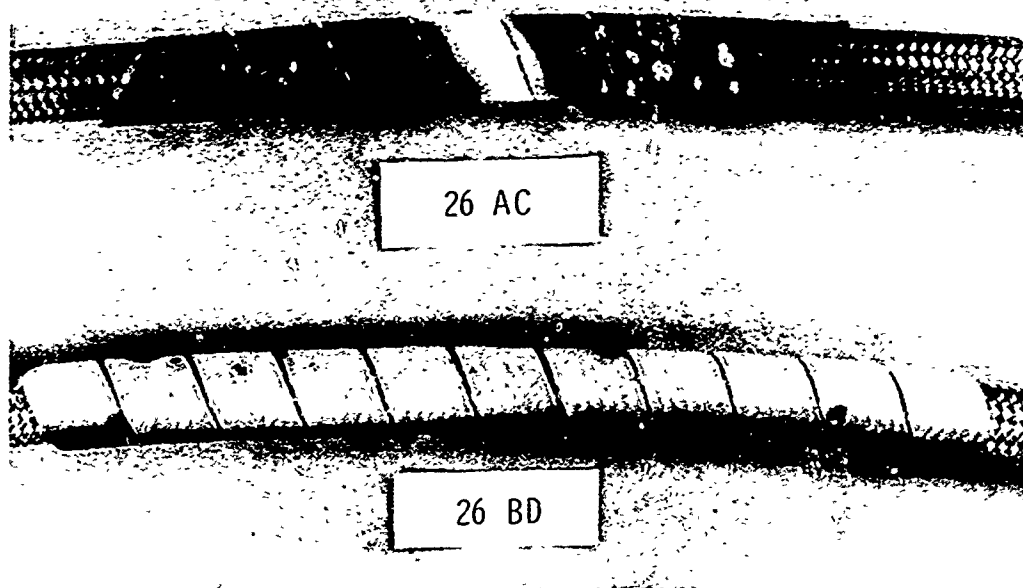

Figure 38. Test Specimens 26AC and 26BD (Nylon Wrapping, 100,000 Seconds Test Time).

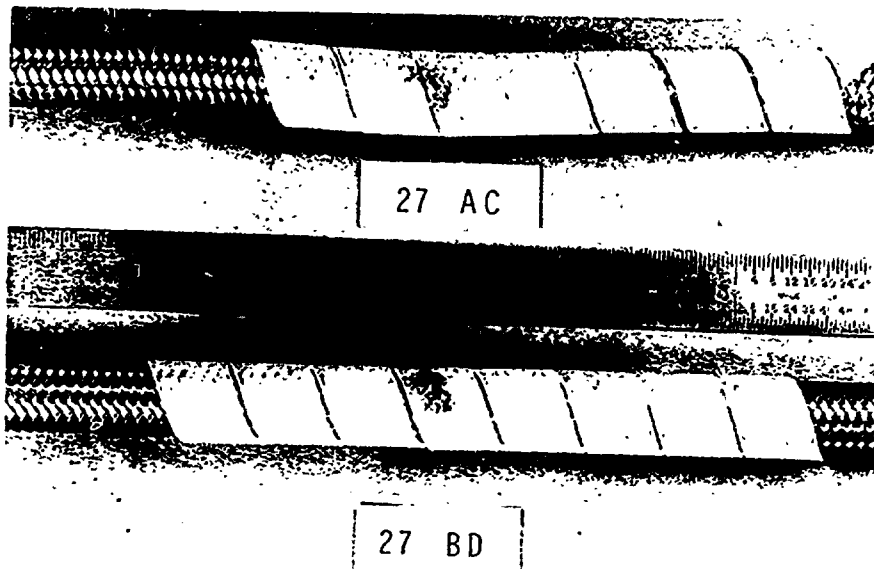

Figure 39. Test Specimens 27AC and 27BD (Nylon Wrapping, 100,000 Seconds Test Time).

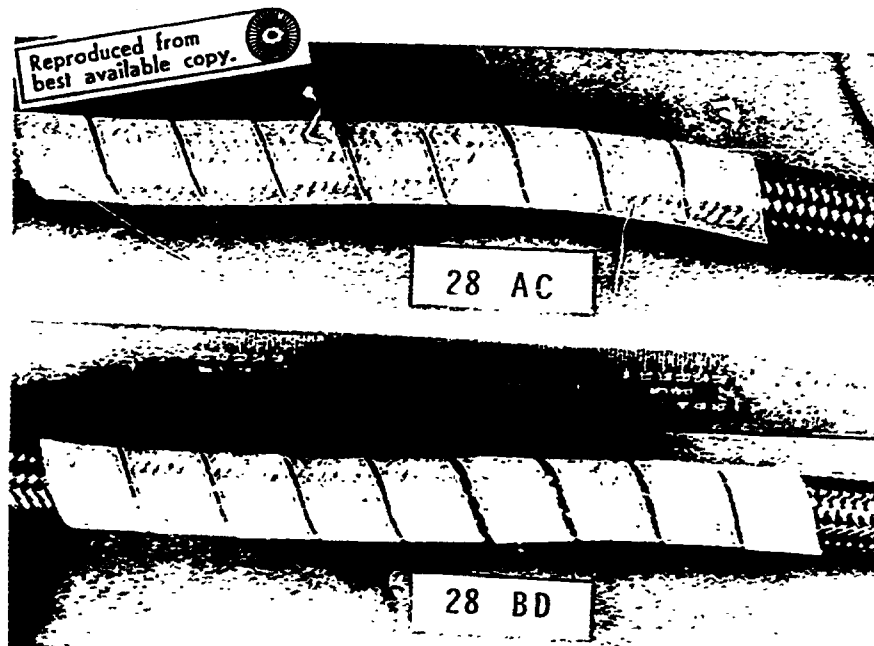

Figure 40. Test Specimens 28AC and 28BD (Nylon Wrapping, 114,000 Seconds Test Time).

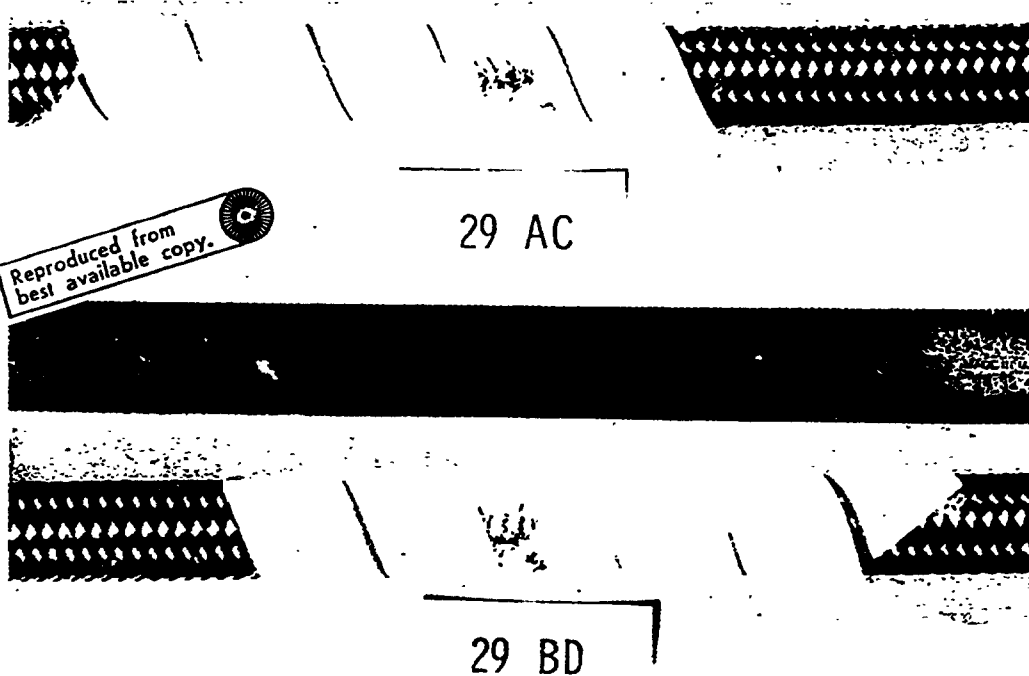
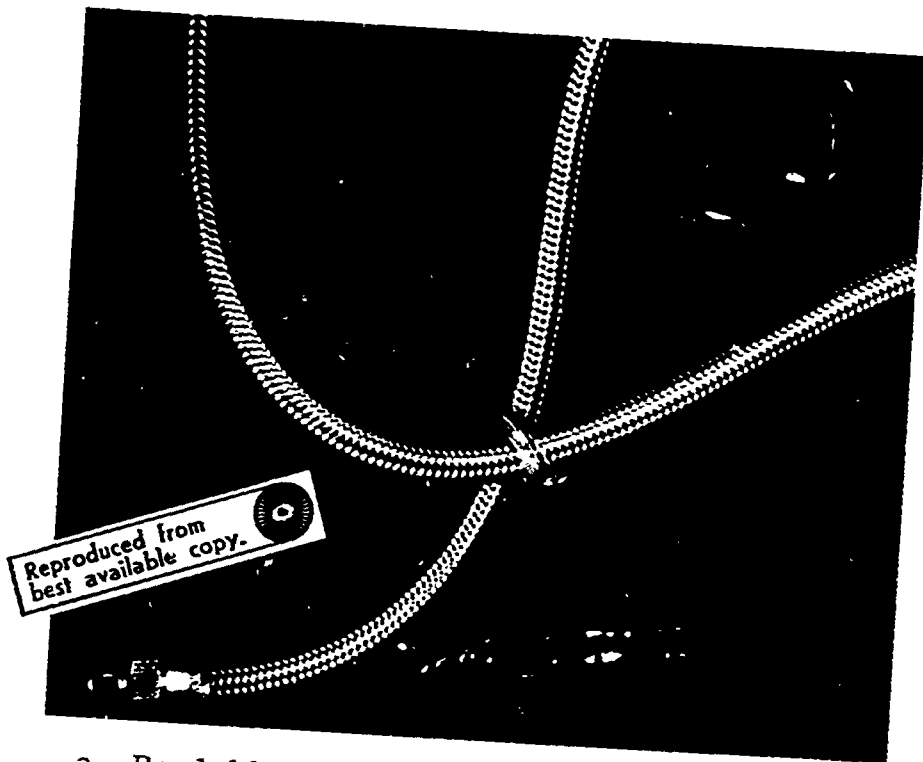

Figure 41. Test Specimens 29AC and 29BD (Tetrafluoroethylene Wrapping).



a. Bonded by Six Strands of Aircraft Safety Wire



30 AC

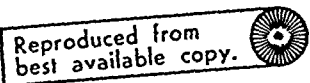

30 BD

b. Separated, 100,000 Seconds Test Time

Figure 42. Test Specimens 30AC and 30BD.

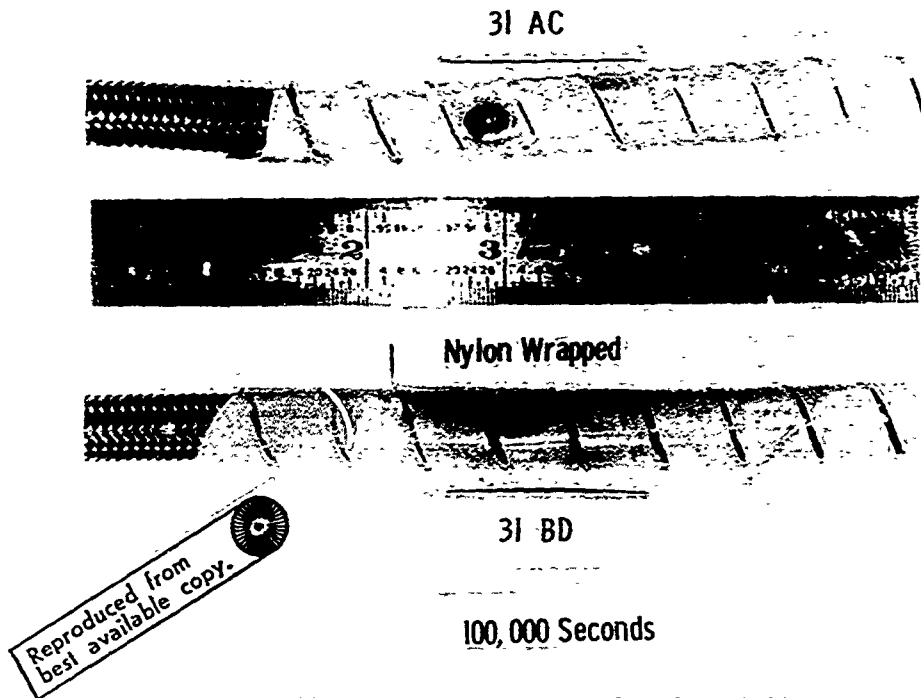

Figure 43. Test Specimens 31AC and 31BD.

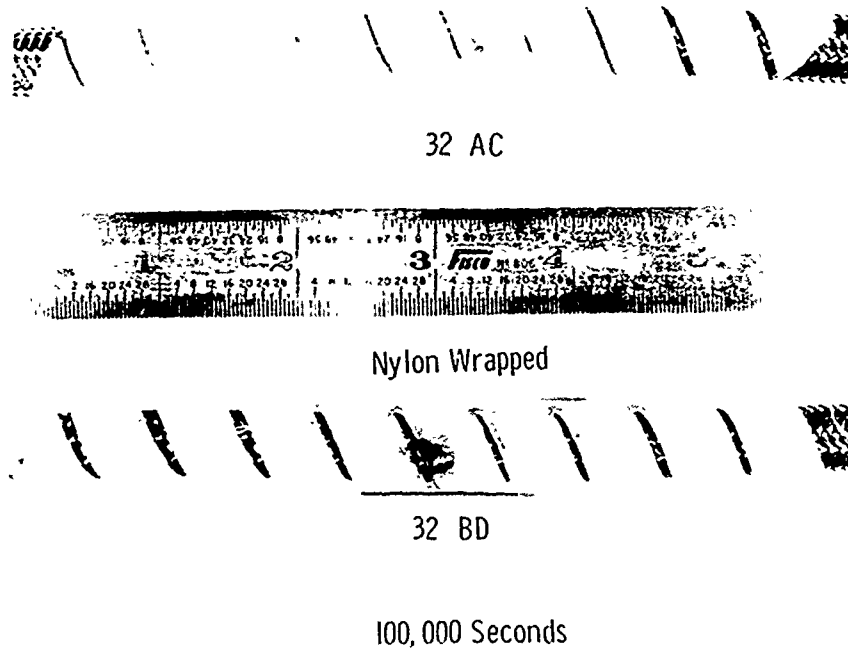
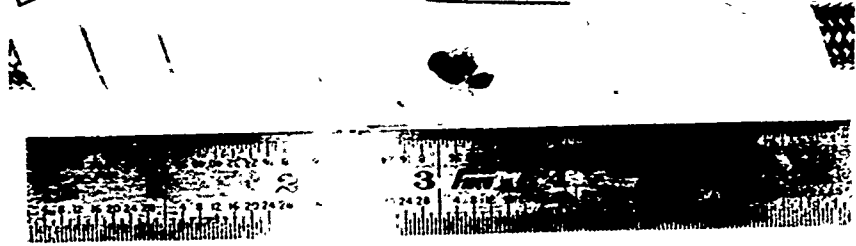

Figure 44. Test Specimens 32AC and 32BD.

Reproduced from
best available copy.

33 AC



Nylon Wrapped



33 BD

Figure 45. Test Specimens 33AC and 33BD.

34 AC

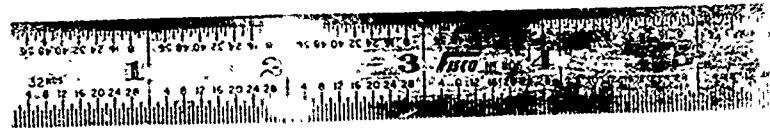

Nylon Wrapped

34 BD

100,000 Seconds

Figure 46. Test Specimens 34AC and 34BD.

35 AC

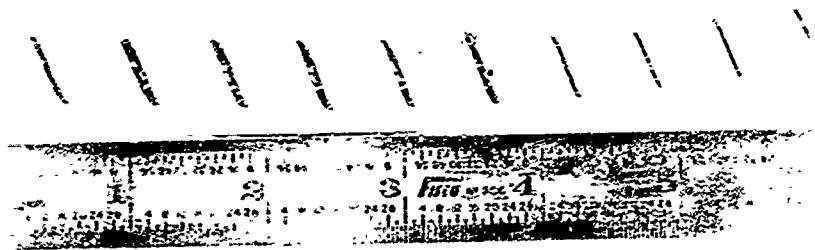

Nylon Wrapped

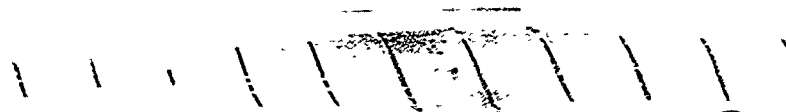

35 BD

Reproduced from
best available copy.

Figure 47. Test Specimens 35AC and 35BD.

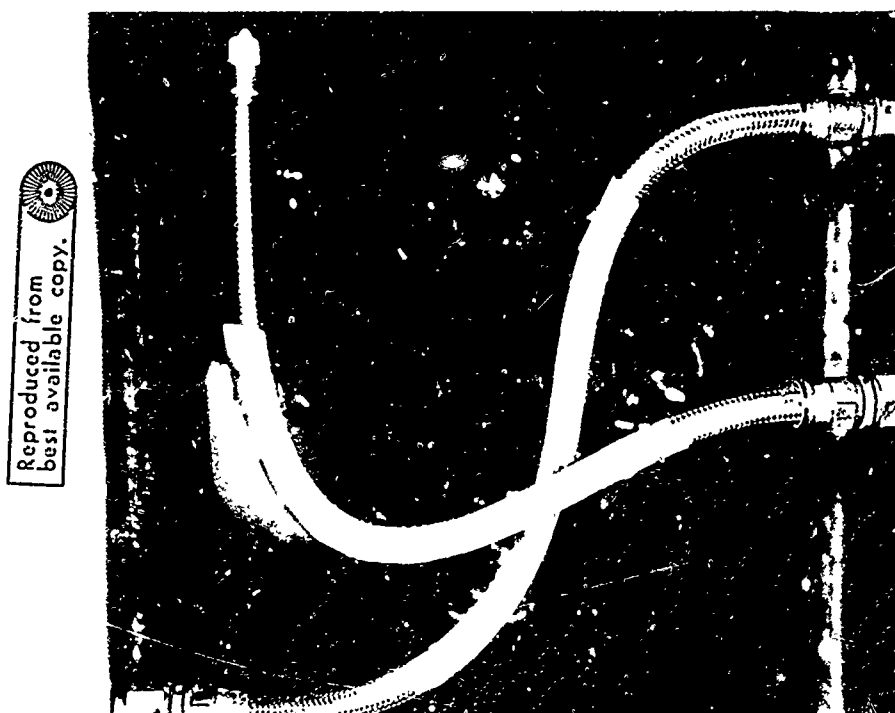
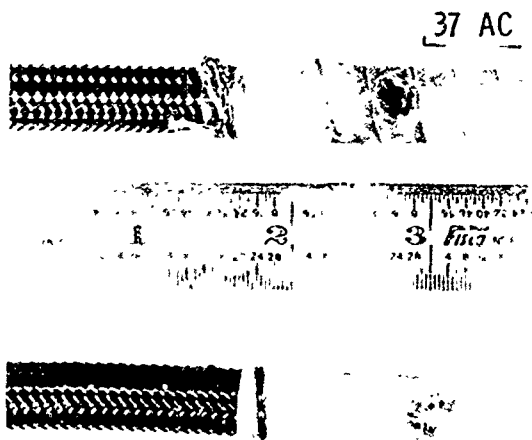

Figure 48. Test Specimens 36AC and 36BD in Test Fixture.



Reproduced from
best available copy.

Figure 49. Test Specimens 36AC and 36BD Separated (Tetrafluoroethylene Tape, One Layer, 101.657 Seconds Test Time).



Reproduced from
best available copy.

37 BD

100,000 Seconds

Figure 50. Test Specimens 37AC and 37BD (Tetrafluoroethylene Tape).

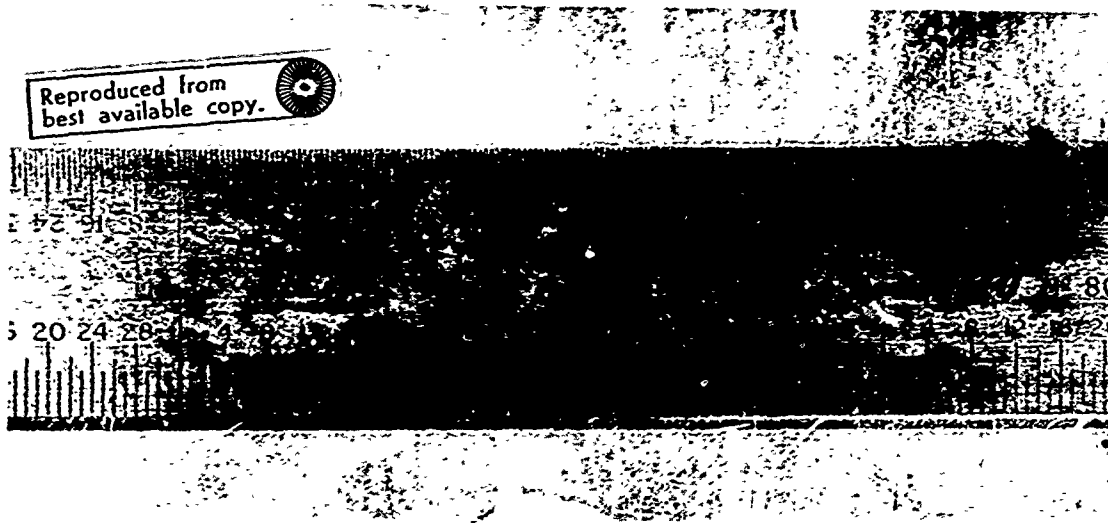

Figure 51. Test Specimen 38AC 2024-T4 Sheet Aluminum (0.032 Inch Thick, 9721 Seconds Test Time, 3/4 Pound Contact Force).



Figure 52. Test Specimen 39AC 2024-T4 Sheet Aluminum (0.062 Inch Thick, 1252.7 Minutes Test Time, 1.0 Pound Contact Force).

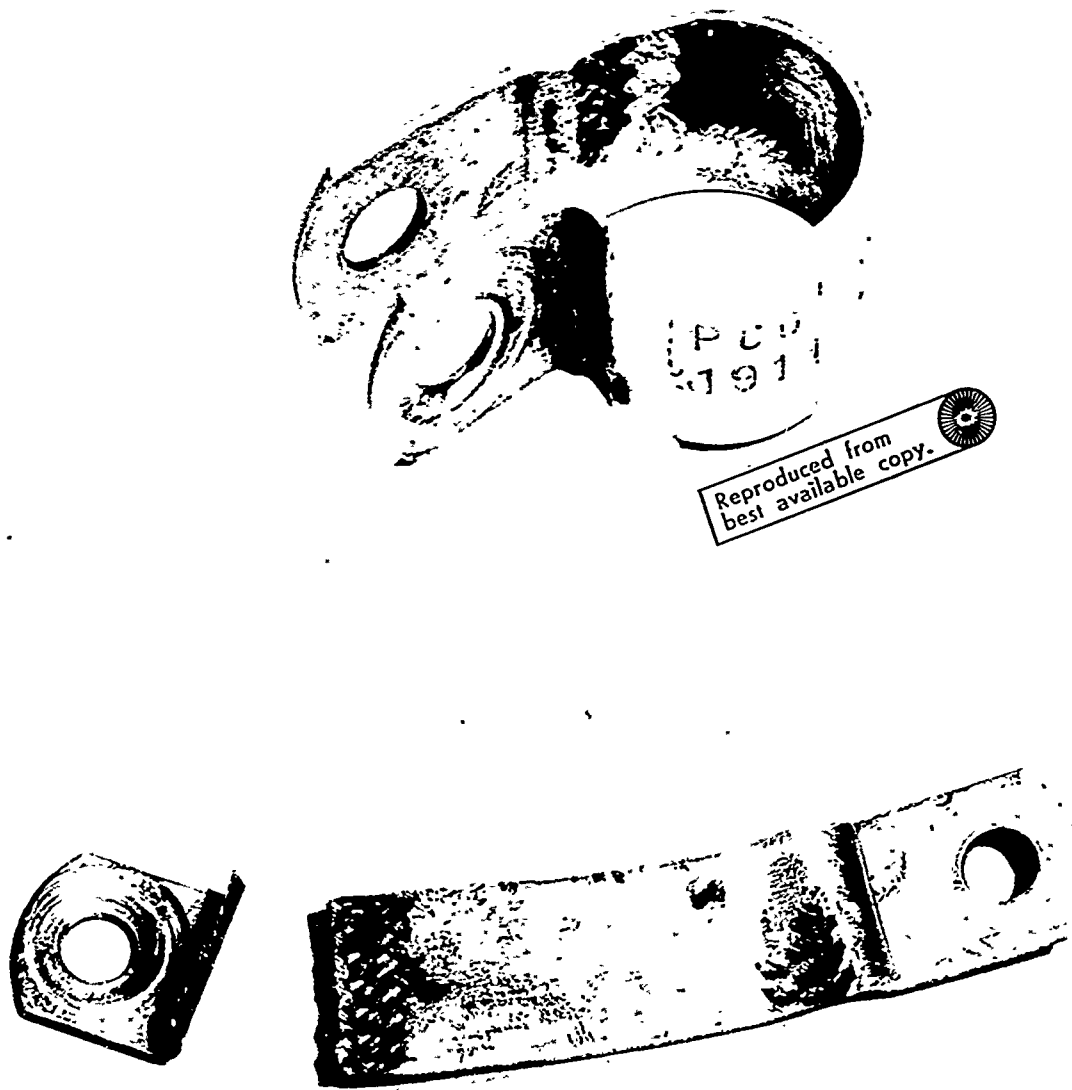

Figure 53. Test Specimen 40AC Clamp No. 7
(77,500 Seconds Test Time).

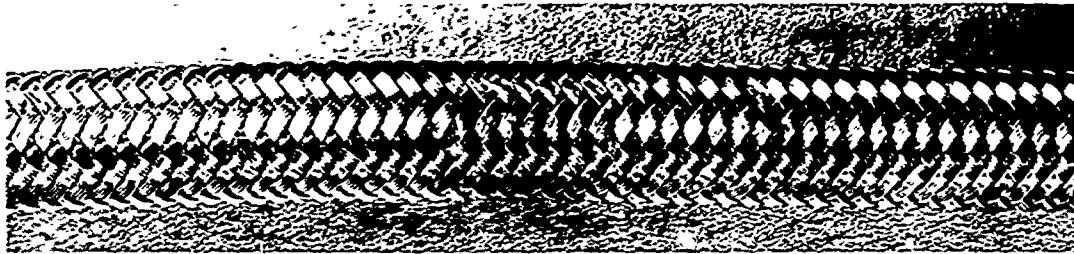

Figure 54. Test Specimen 41AC.

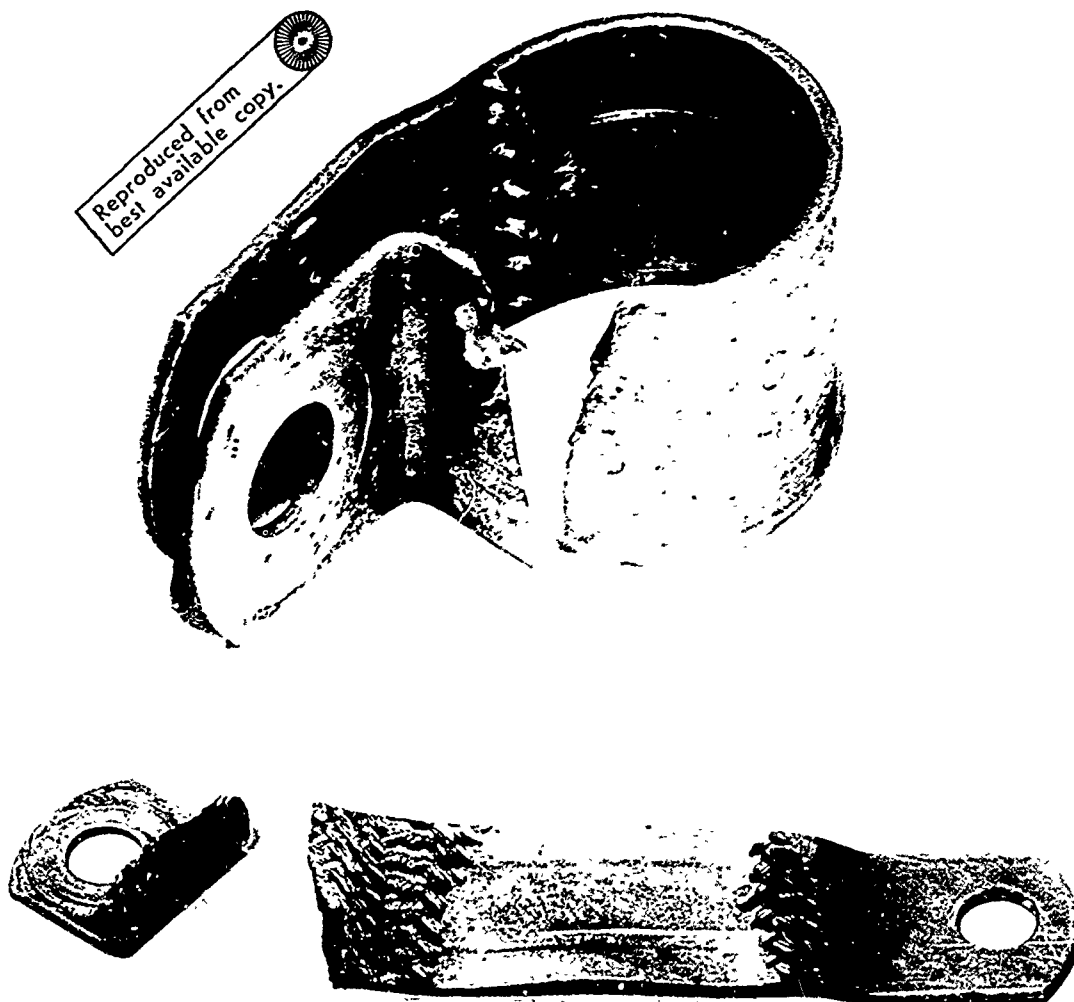

Figure 55. Test Specimen 41AC Clamp No. 6
(73,550 Seconds Test Time).

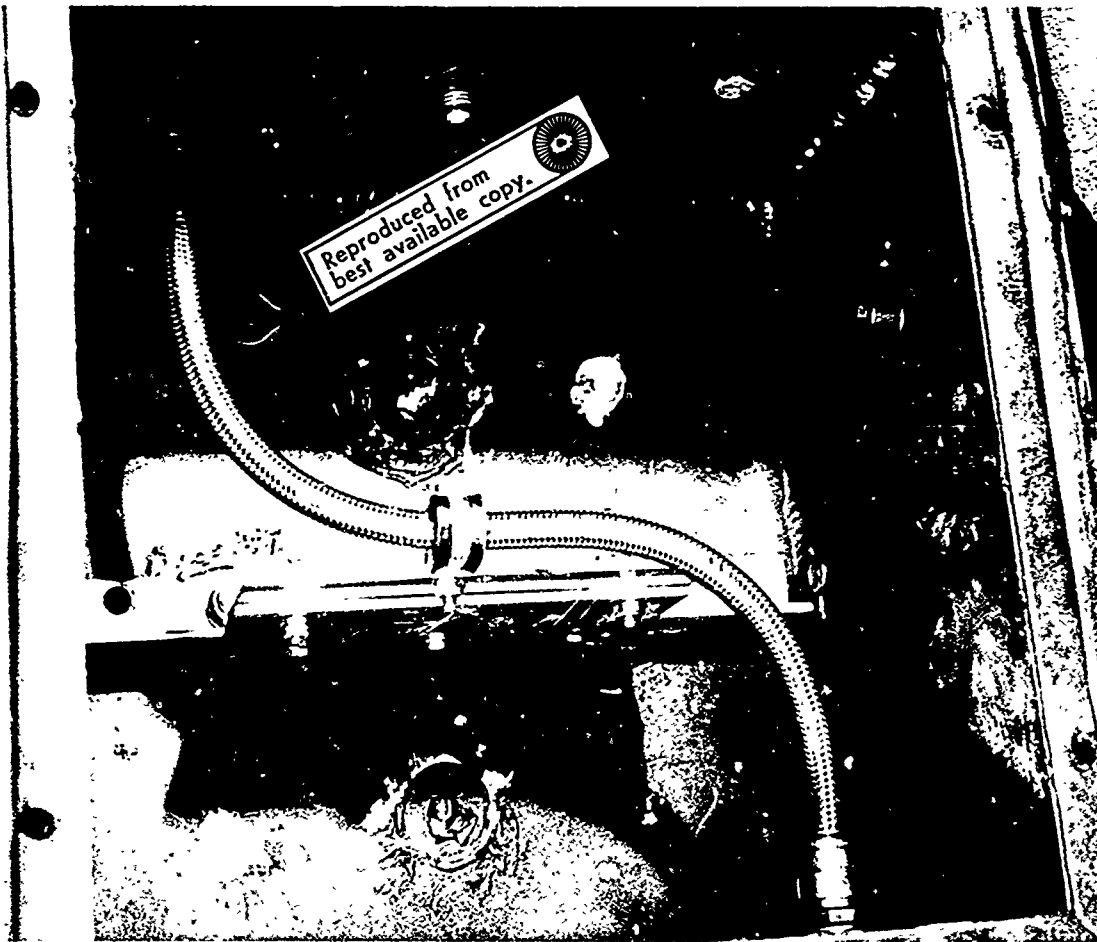

Figure 56. Test Specimen 42AC in Test Fixture With No. 8 MS 21919 Clamp Covered With Hydraulic Fluid and Sand.



Figure 57. Test Specimen 42AC (100,000 Seconds Test Time).



Figure 58. Test Specimen 42AC Clamp No. 8
(100,000 Seconds Test Time).

APPENDIX IV
HOSE CLAMP SUBSTITUTE

Army aircraft wire-braided hoses may come into contact with each other and abrade at the point of contact, causing loss of fluids that could result in loss of functional control of an aircraft. Mechanical separation of the hoses could help prevent their abrading. This is currently being accomplished by a two-piece metal clamp qualified under MS 21919, which uses a rubber or a tetrafluoroethylene bushing between the clamp and the hose.

A proposed replacement for the currently used hose clamp was examined to determine if it would solve any of the problems associated with hose chafing on Army aircraft. The clamp was to be made of polypropylene and would be of the dimensions shown in Figure 59 if it were used on a wire-braided hose whose outside diameter was 0.465 inch.

Polypropylene was selected because it is the lowest density thermoplastic material commercially available and has good molding characteristics. Polypropylene has good strength and resilience, is heat resistant, and displays good resistance to thermal stress cracking. This configuration would have the following characteristics:

1. It may be reused many times.
2. If one end of the spacer comes loose from one of the hoses, it will still provide protection because the remaining attached end will still act as a separator to prevent the hoses from abrading against one another and/or a bulkhead.
3. Failure of the hinge joint between the two hoses leaves two spacer attachment ends still attached to the problem lines that will continue to act as separators until the next inspection.

This proposed replacement clamp was rejected as a fix for the hose chafing problem on Army aircraft for the following reasons:

1. The clamp that is currently being used provides the same protection as the proposed clamp when properly installed. Therefore, no improvement is gained by using the proposed clamp.
2. The proposed clamp is not usable for hose connections that are not parallel.

3. To make enough different sizes and orientations of polypropylene clamps to account for all the different combinations of hose sizes and positions would make the logistical problem unnecessarily complex compared to the logistical problems for the clamp qualified under MS 21919.

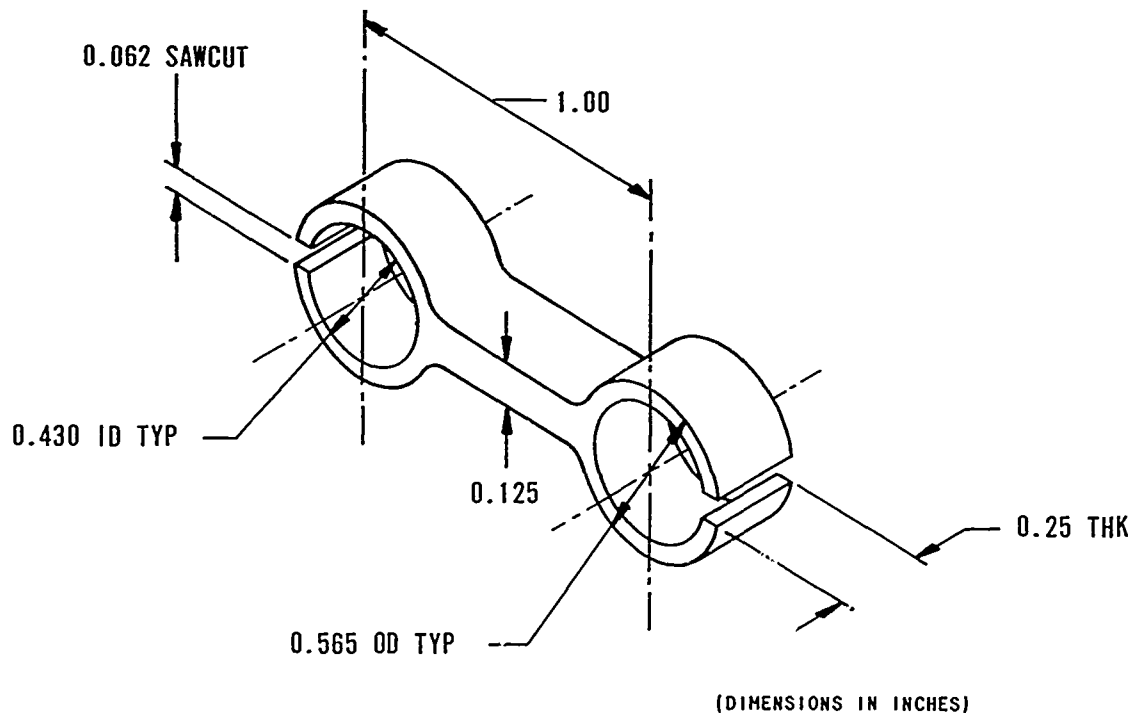

Figure 59. Polypropylene Spacer for Army Aircraft Hydraulic Tubing Separators.